



Copyright 2023  
Edition 11/1/2023  
Price \$10.00

# 25 YEARS EAST PENN TRUCK EQUIPMENT INC

*The Right Choice*

**EASTERN DIVISION**  
1100 WIN DRIVE  
BETHLEHEM, PA 18017  
610-694-9234

**WESTERN DIVISION**  
7298 W. MARKET ST.  
MERCER, PA 16137  
724-342-1800

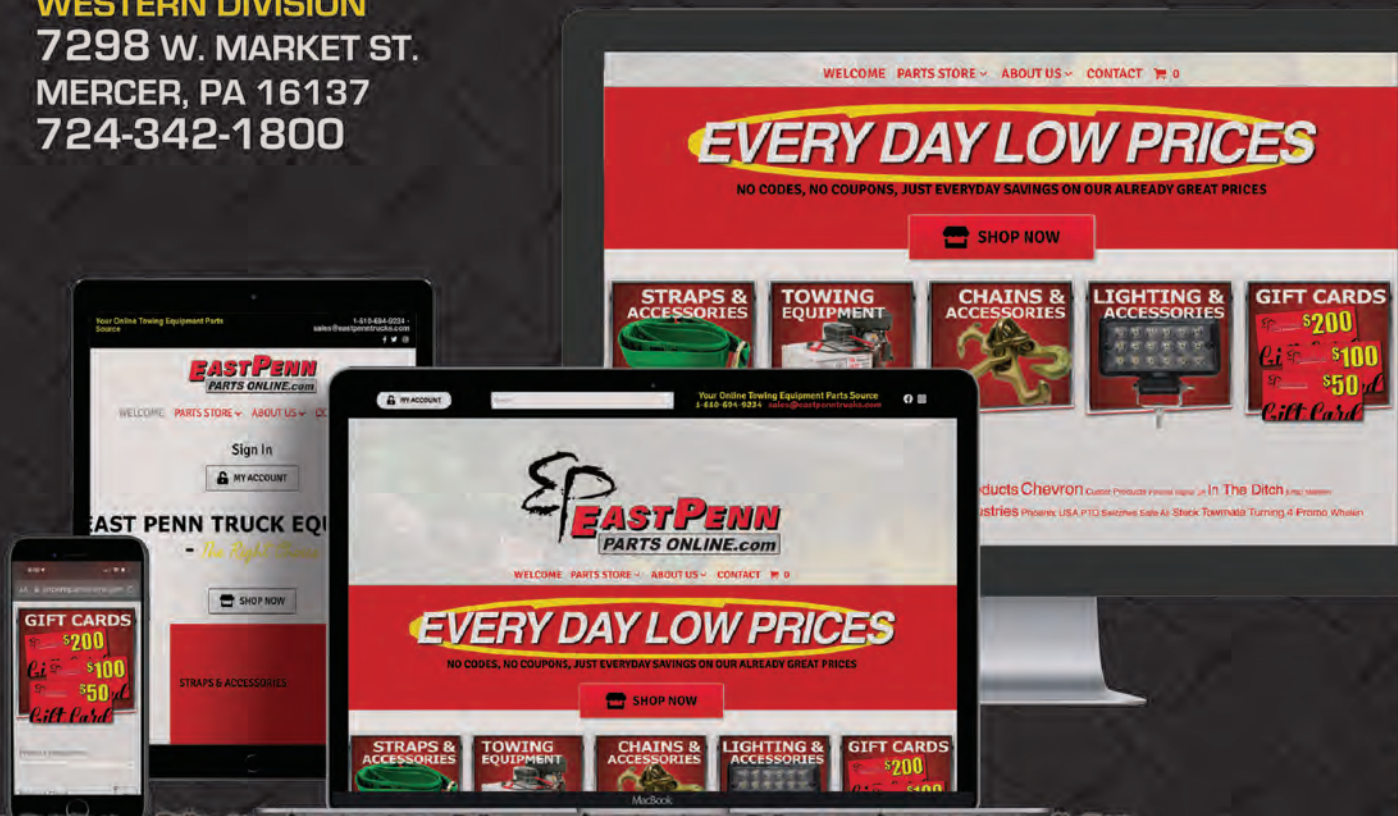

**OPEN 24/7 FOR BUSINESS**  
[www.eastpennpartsonline.com](http://www.eastpennpartsonline.com)

SALES • MANUFACTURING • SERVICE • PARTS  
[www.eastpenntrucks.com](http://www.eastpenntrucks.com) • [www.eastpennpartsonline.com](http://www.eastpennpartsonline.com)



**TOWING SOURCE BOOK**

# What's New at East Penn?

## YOU MAY NOTICE SOMETHING MISSING IN OUR NEW PARTS BOOK

With the ever changing market, prices are always changing so we've decided to remove all of our prices. At East Penn Parts Online, you'll now be able to access current prices and availability on all your favorite brands of towing parts. Our 24/7 parts website now makes your online experience even quicker and easier!

Throw in 100's of products at your fingertips, Gift Cards, Coupons and offers on our already low prices and over 100 truck manuals from all major manufacturers and you'll quickly realize why we're not just not another company selling towing equipment!

[www.eastpennpartsonline.com](http://www.eastpennpartsonline.com) **It's time to make our home yours**



# THE RIGHT CHOICE, EVERY TIME

EVERYDAY SAVINGS ON OUR ALREADY GREAT PRICES AVAILABLE 24/7

- **Everyday Savings**  
No coupons needed
- **Rewards Program**  
Earn while you shop



**Give the Gift of Cash**  
You give the gift,  
they do the shopping



**Find What You Need Fast**  
Search by category,  
by brand or even by our  
best selling products













**Check Out 24/7**  
Don't worry about  
hours, buy what you  
need, when you need it

**EASTPENN**  
PARTS ONLINE.com

Eastern Division: 610-694-9234 | Western Division: 724-342-1800  
For pricing and availability, visit us online at: [www.eastpennpartsonline.com](http://www.eastpennpartsonline.com)

# TABLE OF CONTENTS

*This book serves as a reference guide only, pricing subject to change.*

2-6		Straps & Accessories	28-51		Towing Equipment
7-10		Chains & Accessories	52		Side Pullers
11		Winch Cables & Accessories	53		Switches
12-22		Lighting & Accessories	54		Filters
23-27		East Penn Trucks Info	55		Outerwear

*Copyright 2023 East Penn Truck Equipment.  
Please visit our website for current prices and availability.*

## VISIT OUR SHOWROOM!



## SHOWROOM HOURS

Open Monday-Friday  
8:00am - 5:00pm

Eastern Division : 1100 Win Drive, Bethlehem, PA 18017

Western Division : 7298 W. Market St, Mercer, PA 16137



## EASY ORDERING NOW ONLINE, IN PERSON OR BY PHONE!



Eastern : Call us at 610-694-9234

Western : Call us at 724-342-1800

[www.eastpennpartsonline.com](http://www.eastpennpartsonline.com)

[sales@eastpenntrucks.com](mailto:sales@eastpenntrucks.com)

Eastern Division: 610-694-9234 | Western Division: 724-342-1800  
For pricing and availability, visit us online at: [www.eastpennpartsonline.com](http://www.eastpennpartsonline.com)

# STRAPS

## Wheel Lifts

WWW.EASTPENNTUCKS

East Penn Truck Equipment only supplies you with the best quality wheel lift straps made. Our straps are made tough to withstand the everyday wear and tear of the job. All of our products are USA assembled.



**2" Universal Tough Edge Strap w/ D Ring**  
Used with Century, Challenger, and NoMar branded wheel lifts as well as other name brands.

**P/N: 38-1** 8'  
**P/N: 38-1-9** 9'  
**P/N: 38-1-12** 12'



**2" Tough Edge Strap w/ clusters**  
A cluster tie down with hammerhead, mini J hooks and T hook.

**P/N: 38-100S**



**2" Tough Edge Strap w/ Snap Hook**  
Used on wheel lifts where cross over style tie down is used.

**P/N: 38-8**

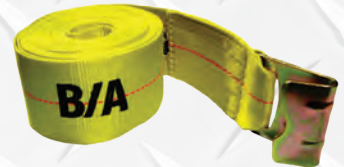

**2" Strap with HD Flat Hook**  
Replacement wheel lift strap with flat hook on one end.

**P/N: 38-2**



**2" Tough Edge Strap w/ Mini J**  
Tough edge strap with mini J on one end.

**P/N: 38-5J**



**2" Chevron Tough Edge Wheel Strap**  
Used with Chevron wheel lifts.

**P/N: 38-1A**



**2" Tough Edge Strap w/ Snap Hook**  
Used on Dynmaic wheel lifts.

**P/N: 38-3**



**2" Tough Edge Double Finger Hook**  
Used on multiple wheels where wrap around style is needed.

**P/N: 38-4**



**2" Tough Edge Strap w/ Sewn Loop**  
Used on multiple brand wheel lifts including Jerr-Dan style.

**P/N: 38-5**



**14" Tough Edge Cross Strap**  
Replacement cross strap with lined eyes for tie down systems.

**P/N: 38-200S**



**2" Tough Edge Strap w/ Chain End**  
Replacement strap with chain for tie down systems.

**P/N: 38-200-CL**



**26" Axle Strap**  
3 Ply axle strap with D rings on both ends.

**P/N: 38-50-26**

East Penn Truck Equipment only supplies you with the best quality straps made. Our OEM straps are made tough to withstand the everyday wear and tear of the job.



**East Penn Exclusives**



**Chevron Basket Strap**  
Replacement basket strap used for Chevron or Challenger wheel lifts. (3) T hooks with 32" chain. New design for larger SUV wheels.

**P/N: 38-62CL3EP**

**Chevron Truck Basket Strap**  
Replacement strap for Chevron or Challenger wheel lifts. T hook on one side and 32" chain on the other. Web straps help secure tire.

**P/N: 38-64**

**Basket Straps w/ Hooks**  
Replacement basket strap with two open hooks on one end and 2" strap on the other for use with ratchet.

**P/N: 38-6**



**1" Vinyl Coated Basket Strap**  
One cross strap with two T hooks. Commonly used with Century bodies.

**P/N: 38-61**



**DOT Approved Chain Binder**  
Tie down basket strap with ratchet & chains.  
**P/N: 11-RT100**

**Others Are Available Upon Special request**

## CARGO STRAPS



2" Ratchet tie-down with double J hooks  
**P/N: TD2-15DJ 15"**  
**TD2-20DJ 20"**  
**TD2-27DJ 27"**  
**TD2-30DJ 30"**

4" Ratchet tie-down with double J hooks  
**P/N: TD4-15DJ 15"**  
**TD4-20DJ 20"**  
**TD4-27DJ 27"**  
**TD4-30DJ 30"**



2" Ratchet tie-down with flat hooks  
**P/N: TD2-15FF 15"**  
**TD2-20FF 20"**  
**TD2-27FF 27"**  
**TD2-30FF 30"**

4" Ratchet tie-down with flat hooks  
**P/N: TD4-15FF 15"**  
**TD4-20FF 20"**  
**TD4-27FF 27"**  
**TD4-30FF 30"**

# STRAPS

## DOT Approved Car Carrier Tie Downs

East Penn Truck Equipment only supplies you with the best quality tie down systems made. Our straps are made tough to withstand the everyday wear and tear of the job. Below are a variety of D.O.T. approved tie down systems.



8 Point Tie Down Car Carrier Set  
P/N: 38-200



8 Point Tie Down Car Carrier Set  
P/N: 38-200C



Tough Edge Car Carrier Assembly  
P/N: 38-100



8 Point Tie Down Car Carrier Set  
P/N: V38KITD12



Double Finger Tie Down Strap  
EP Exclusive!  
P/N: 38-HL9-EP



Tough Edge Car Carrier Assembly  
P/N: 11-RT100



Basket Strap with Ratchet & Chain  
Tie down basket strap with ratchet & chains.  
P/N: 38-B19R



Tough Edge Car Carrier Assembly  
P/N: 38-106



Motorcycle Caddy

Innovative speed ramp on this cycle caddy provides effortless loading of motorcycles. Light weight, compact and durable, this cycle caddy has what it takes to tow motorcycles up to 950 pounds. Ratchets not included.

P/N: ITD-ITD1412



Motorcycle Sling Strap Kit

2 Motorcycle sling straps with carrying case. Never misplace your straps again! Sold as a kit.

P/N: 21-1



Motorcycle Tie Downs

1 x 12" double J hook and ratchet. Works well when attaching motorcycle to car carrier tie downs.

P/N: TD1- RD12J



Cam Style Motorcycle Tie Down

1 x 18" cam style motorcycle tie down. Vinyl S-hooks hold motorcycles without scratching. Quick release cam buckles adjust the length to your specifications. Sold individually.

P/N: TD1-RC18S

View more tie down straps on [eastpennpartsonline.com](http://eastpennpartsonline.com)!

# Ratchets

# STRAPS ACCESSORIES



38-10C



38-10A



38-100R



38-22D



38-14



38-13



38-11



38-20



38-10



38-10B



38-10F



38-8100R

Ratchets feature a patented double locking mechanism that offers double security making the ratchet more difficult to loosen or open during your tow. Never exceed the Work Load Limit (WLL.)

ITEM #	DESCRIPTION	WLL
38-10C	Double Finger Hook	1,665lbs.
38-10A	Single Finger Hook	1,665lbs.
38-100R	Ratchet w/ Chain	3,670lbs.
38-22D	Snap Hook	2,200lbs.
38-10	Standard	3,670lbs.
38-10B	Tab	1,665lbs.
38-14	Parallel Hook	1,665lbs.
38-13	Snap Pin	3,300lbs.
38-11	Retainer	1,665lbs.
38-20	Wide Handle Std	3,670lbs.
38-10F	Bent Finger Hook	2,000lbs.
38-8100R	Gradual Release w/Chain	3,670lbs.

Now Open

24/7

SHOP DAY & NIGHT

SAME CONVENIENCE  
OF OUR SOURCE BOOK  
NOW ONLINE!

*The Right Choice*

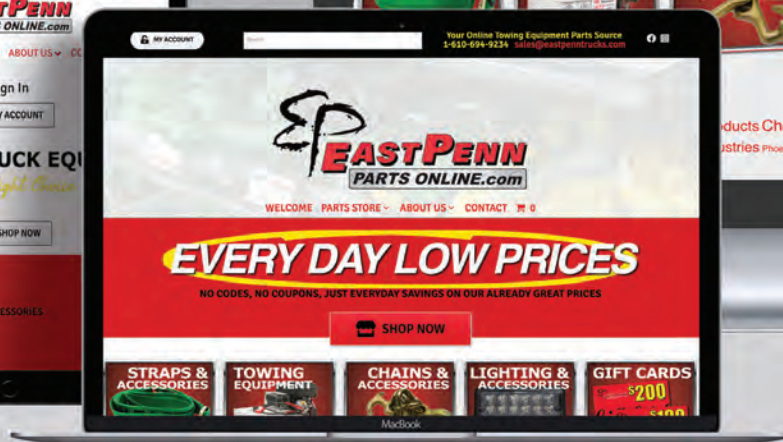
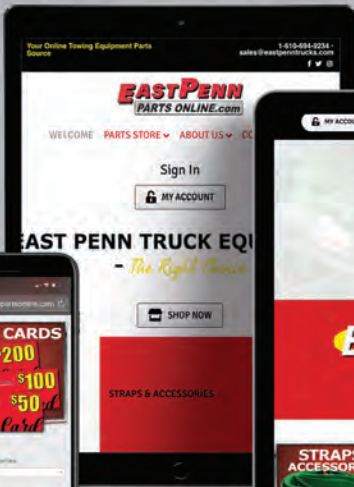
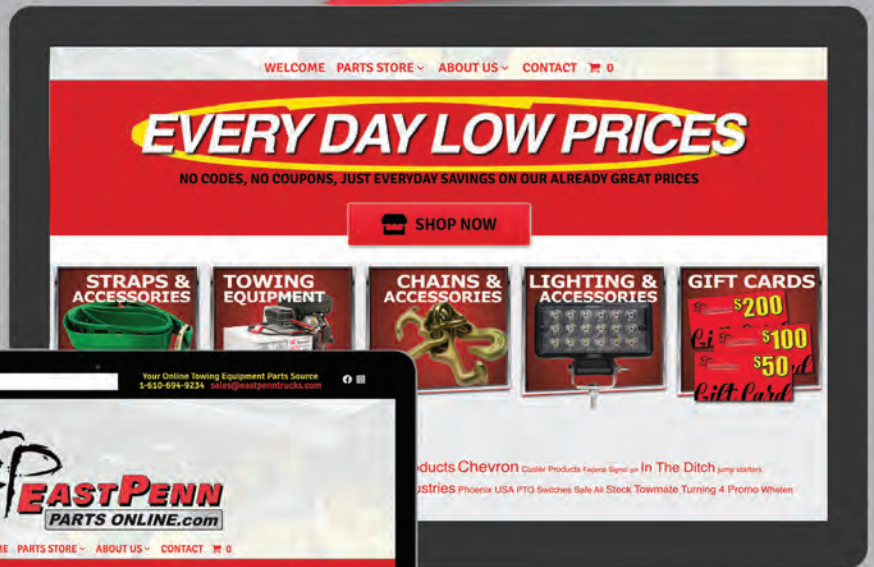

[www.eastpennpartsonline.com](http://www.eastpennpartsonline.com)



# New Low Profile V-Chain Assemblies

## CHAINS

East Penn Truck Equipment only supplies you with the best quality products. Our bridles are made tough to withstand the everyday wear and tear of the job and survive rust and corrosion.



### Sports Car V-Assemblies

- Grade 70 zinc plated forged chain
- 4,700lb WLL
- 3" 3ply provides durable protection
- Tower's Edge cordura webbing
- Assemblies are 24" in length
- Ideal for compact cars

**N711- 8CJ** 8" J hooks w/ mini J hooks



### Long "J" Hook Assemblies

- Grade 70 zinc plated forged chain
- 4,700lb WLL
- 3" 3ply provides durable protection
- Tower's Edge cordura webbing
- Assemblies are 24" in length

**N711- 8CLT** Long 15" J hook w/ T hooks



### V-Strap with cluster 24 inch legs

- Low Profile

**P/N: LP11-8CLU**



### V-Chain w/ Mini J & T 8" Hook

**P/N: LP11-8DT**



### V-Chain w/ Hammerhead 15" Hook

**P/N: LP11-8H**



### V-Chain Assembly with 8" hooks

**P/N: LP11-8D**



### V-Chain with cluster 3 foot legs

**P/N: LP11-8LU**



### V-Chain Assembly with 15" hooks

**P/N: LP11-8**

# CHAINS

## Grade 70 Chain Assemblies

### Grade 70 Assemblies 4,700 WLL

N711-1	15" Hook	8'
N711-6	15" Hook	10'
N711-6J	15" Hook	10'
N711-6H	15" JHook w/Grab & Hammerhead	10'
N711-6LUG10	15" JHook w/Cluster	10'
N711-11D	5/16" Chain w/5/16" Slip Hook	10'



N711-1  
Sold in pairs

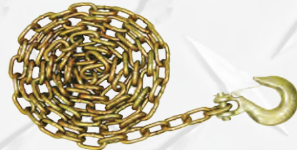

N711-11D  
Sold in pairs



N711-6J  
Sold in pairs



N711-6H  
Sold in pairs



N711-6  
Sold in pairs



N711-6LUG10  
Sold in pairs

# CHAINS

## Hooks/Hardware

### Fittings & Hook Clusters



11-7D Mini Grab



11-7J Mini J Hook



11-7H Mini T & J Hook



8" Forged J  
P/N: N711-10



15" Forged J  
P/N: N711-2



Grab Hook, Forged Mini J-Hook, R-Hook T-Hook

P/N: 11-7CLG



Forged Mini J-Hook, T-Hook, & R-Hook

P/N: 11-7CLG



Pair of grab hooks on pear link

P/N: N711-8E



Slip Hook with Latch  
*Ideal for making assemblies!*

Grade 70 steel slip hook including a spring loaded latch. Attach w/ clevis pin

P/N: 11-38G7SHL



Clevis Grab Hook  
*Ideal for making assemblies!*

Grade 70 steel grab hook with cotter pin attachment included.

P/N: 11-38G8H

All hooks and hardware available in additional grades and options.



**Goodall**  
By VAN AIR.



**PROVIDING STATE OF THE ART POWER SOLUTIONS  
FROM AIR-COMPRESSORS-WELDERS-GENERATORS & MORE!**



**VAN AIR**  
MOBILE POWER SOLUTIONS™



**AIR N ARC** ▶  
150



**AIR N ARC** ▶  
250



**AIR N ARC** ▶  
300 SERIES



**POWERFLEX** ▶  
SERIES

**AVAILABLE AT EAST PENN**



**3/8 G120 Sling Hook**  
Grade 120 slip hook with spring loaded latch. With eye hook.  
(multiple sizes & grades available)

**P/N: G12-38ESHL**



**Double Clevis**

A simple cotter and pin attachment method. Use for grade 70 chain.

**P/N: 11-3DC1 5/16"**

**P/N: 11-3DC2 7/16"**



**Chain Style Container Eye Link**  
Designed to fit the corner eyes of shipping containers.

**P/N: CL-1034**



**Anchor Shackles**

Anchor shackles with screw pin. Can be used to repair links to fitting attachments. The uses are endless.

**P/N: 11-38SPAS**

**P/N: 11-58SPAS**

**P/N: 11-34SPAS**



**Web Sling Container Eye Link**  
Designed to fit the corner eyes of shipping containers as an attachment point for rigging.

**P/N: CL-7034**



**Wide Body Shackles**

Simple design which makes them easy to use over and over again.

**P/N: 11-WBS7 3/4"**

**P/N: 11-WBS125 1"**

**P/N: 11-WBS18 1.25"**

**P/N: 11-WBS30 1.5"**



**Quick Pin Web Shackles**

Fastest way to connect web shackles to eyes on recovery strap.

**P/N: 9-S2 2"**

**P/N: 9-S3 3"**

**P/N: 9-S4 4"**

**P/N: 9-S6HD 6"**



**The Buckle**

The buckle works great as an attachment point or a device used for shortening recovery.

**P/N: WM-701124 4"**

**P/N: WM-701125 6"**

# Wire Rope

# WINCH CABLES / ACCESSORIES



**Standard Hook  
Special Order**

### Self Locking Wire Rope

3/8 x 50'	438PS50LH
3/8 x 75'	438PS75LH
3/8 x 100'	438PS100LH
3/8 x 150'	438PS150LH
1/2 x 75'	412PS75LH
1/2 x 100'	412PS100LH
1/2 x 150'	412PS150LH
1/2" x 200'	412PS200LH

### Swivel Wire Rope

3/8 x 50'	438PS50S
3/8 x 75'	438PS75S
3/8 x 100'	438PS100S
3/8 x 150'	438PS150S
7/16 x 50'	4716PS50S
7/16 x 75'	4716PS75S
7/16 x 150'	4716PS150S
1/2 x 75'	412PS75S
1/2 x 100'	412PS100S
1/2 x 150'	412PS150S
1/2 x 200'	412PS200S



**If you don't see the size you need, we can get it for you! Give us a call today for your specific wire rope needs.**



### Replacement Latches

Latch and spring used on most of today's loaded latches and older profile eye hooks that have single hole.

<b>P/N: 4-2TL</b>	<b>2 Ton</b>
<b>P/N: 4-3TL</b>	<b>3 Ton</b>
<b>P/N: 4-5TL</b>	<b>5 Ton</b>
<b>P/N: 174007107</b>	<b>11 Ton</b>



### Wire Rope Cable Clamp

Heavy Duty wire core clip.

<b>P/N: 4-38WRC</b>	<b>3/8"</b>
<b>P/N: 4-716WRC</b>	<b>7/16"</b>
<b>P/N: 4-12WRC</b>	<b>1/2"</b>
<b>P/N: 4-58WRC</b>	<b>5/8"</b>



### Snatch Block with Safety Latch Swivel Hook

Bronzed brushed and grease-fitted. Includes safety latch and drop-down side panel to easily insert cable.

<b>P/N: 6I-2T3</b>	<b>2 Ton</b>
<b>P/N: 6I-3T3</b>	<b>3 Ton</b>
<b>P/N: 6I-4T4</b>	<b>4 Ton</b>



### Imported Snatch Blocks with Shackle

Features a screw pin shackle that attaches quickly and securely to D-rings or boom ends.

<b>P/N: 6I-SW2T</b>	<b>2 Ton</b>
<b>P/N: 6I-SW4T</b>	<b>4 Ton</b>



### Snatch Block w/ Chain

Snatch blocks include chain and come in either 2 ton or 4 ton option.

<b>P/N: 6I-2TSW30</b>	<b>2 Ton</b>
<b>P/N: 6I-4TSW30</b>	<b>4 Ton</b>

## Warning Lights



### MicroPulse C Series LED Light

C Series perimeter exterior light with 6 high powered LEDs. Single and split color models available.

**P/N: FS MPSC-A**



### Whelen M6 Light Kit

**P/N: MI 124004444**



### LED Flex Lamp Rear Marker Lights

**P/N: MI 124004452**



### Federal Signal FireRay 400 Series

**P/N: FS FR4C-A (Amber)**

**P/N: FS FR4C-AW (Amber/White)**

**Chrome Flange P/N: FS FR4MC**

**Black Trim Ring: P/N: FS FR4MB**



### Thin Profile Surface Mount Warning Light

This 6 inch oval warning light comes with 14 LED's in 8 flash patterns. This light comes in red, amber or white.

**P/N: MX M63353R Red**

**P/N: MX M63353Y Amber**

**P/N: MX M63353WCL White**

**P/N: MX M50146 Bezel**



### Federal Signal MicroPulse Ultra

**P/N: FS MPS61U-A (Amber)**

**P/N: FS MPS61U-AW (Amber/White)**



### Federal Signal FireRay 600 Series

**P/N: FS FR6C-A (Amber)**

**P/N: FS FR6C-AW (Amber/White)**



### Federal Signal MicroPulse C-Series

**P/N: FS MPSC-A (Amber)**



### Federal Signal MicroPulse

**P/N: FS MPSW6-A (Amber)**

**P/N: FS MPSW6-AW (Amber/White)**

Surface Mount LED Warning Lights are an affordable and effective way to bring visibility to your truck. They are offered in many varieties and include a plastic bezel.

*Maxxima warning lights available in additional flash and color options*



Ultra thin Maxxima warning light with 3 LED Ambers.

**P/N: MX-M20383YCL**



Ultra thin Maxxima warning light with 18 LED-flashable patterns.

**P/N: MX-M20384YCL**



Maxxima warning light with 28 flash patterns.

**P/N: MX M20389WYCL**



Maxxima warning light with 1,800 Lumen LED scene light.

**P/N: MX MWL-32**



**Safe All Roll King**

Collapsible and adjustable stiff leg for rollover recoveries

**P/N: SA RK**



**Safe All Driveline Pro**

Adjustable for driveshaft repositioning

**P/N: SA DLP**



**Safe All Remote Brake Assist**

Works with both air and hydraulic brakes

**P/N: SA RBA**



**Safe All Remote Control**

Precise proportional control operation – providing the ability to feather the hydraulic function(s) in both directions

**P/N: SA RC**

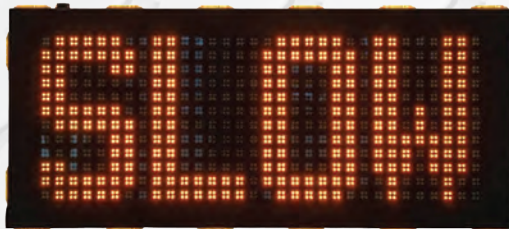

**Safe All Traffic Commander**

- Dimensions: 62"W x 26"T x 6"D
- 4 sealed LED black bricks (IP67 certified)
- 18"T amber words and arrows (MUTCD standards)

**P/N: SA TC**



**Digital and LED message boards for vehicle or trailer mounting – call us for more details!**



**Whelen Vertex Universal Hide-A-Way Strobe**

The Whelen® Vertex™ is a small semi-hemispheric LED lighthouse and is perfect for most applications where size and intensity are critically important. Self-contained unit using an in-line combination lamp driver/flasher. Only 7/8" in height.

**P/N: PH VTX609A**

**P/N: PH VTX609W**

**CHROME FLANGE OPTION**

**Amber**

**Clear**

## Work & Compartment Lights



**Compact Work Light**  
This compact square work light features 2 Philips LUXEON M LED's, 1,350 lumens, polycarbonate lens and a black coated aluminum housing. 4.1"x3.2"x2.7".

**P/N: MX MWL-31SP**



**Multipurpose LED**  
*Round high intensity work light*  
This work light features a white high intensity LED heavy duty light with black painted aluminum alloy housing flood beam.

**P/N: ALT W0904510P**



**Exterior Scene Work Light**  
This rectangular work light features 24 LED's, 1,400 lumens, polycarbonate lens and cast aluminum housing. The measurements are 2"x9".

**P/N: MX MWL-34**

**LED Work Light**  
*This LED work light has 9 LED's, 2100 Lumens, black aluminum housing and an easy grip handle.*

**P/N: MX MWL-36**



**Exterior Scene Work Light**  
This rectangular work light features 24 LED's, 1,500 lumens, polycarbonate lens and cast aluminum housing. The measurements are 4"x6".

**P/N: MX MWL-35**



**Rectangular Work Light**  
This work light features 18 LED's, 3,100 lumens, polycarbonate lens and cast aluminum housing. 7.1"Wx3.7"Hx2.2"D.

**P/N: MX MWL-58**



**Mini-Square Work Light**  
*Compact and Economical!*  
This mini work light features 4 LED's, 800 Lumens, 12VDC and 1.25amps. 3 1/4" x 4 1/4".

**P/N: MX MWL-20P**



**4" Square Multipurpose LED**  
*High Intensity Work Light*  
This work light features a white high intensity LED heavy duty worklight with black painted aluminum alloy housing flood beam. 27 watts.

**P/N: ALT W0904530P**

Lumitec LED H120 Light

**P/N: MI 50002172**



**Compact Interior Compartment Light**  
This low profile interior compartment light has 15 LED's and 240 lumens. It is constructed with a polycarbonate housing and lens. Can be mounted on any flat surface. 1 3/8"x 5 3/4".

**P/N: MX M84446CH**



**LED Strip Lighting**  
Silicone LED interior strip lighting offers flexibility when applied to tight radiuses. Comes in cool white, with an easy to install self-adhesive backing.

**P/N: MX MSLS-2436 24"**

**P/N: MX MSLS-3654 36"**

**P/N: MX MSLS-4569 45"**

**P/N: MX MSLS-78120 78"**



**Round Multipurpose LED**  
*High Intensity Work Light*  
This work light features a white high intensity LED heavy duty worklight with black painted aluminum alloy housing flood beam. 18 watts.

**P/N: ALT W0604510P**



Lumitec LED Boom Scene Light

**P/N: MI 124004628**



# LED Lightbars

# LIGHTING

## Allegiant 61" light bar

developed by East Penn and built by Federal Signal. This light bar allows you flash dual color combinations, all in one light bar! Amber Only, Amber & White, Amber, White & Blue. The Allegiant 61" light bar has discrete 9 conductor cabling, SpectraLux multi-color LED Technology and 28 flash patterns. No other light bar offers this level of flexibility.

### Features:

- Stop/Turn/Tail Lights
- Exclusive Bed/ Work light function
- Class 1, CAC Title 13
- 30.2 lbs.
- 61"L x 2"H x 11-1/5"D
- 5-Year Warranty
- Additional color and functionality configurations available



**60" Freedom Lightbar** Intense wide angle light for a great price!

- (4) LED modules, (2) work lights, (2) LED S/T/T - Wide angle light producing intense light
- 12 vdc / Flat mount - Class 1 SAE certified - 60"L x 12" W x 3 3/4" H



**72" LED Lightbar** Intense wide angle light for a great price!

- (16) LED modules, (2) work lights, (2) LED S/T/T - Wide angle light producing intense light
- 12 vdc / Flat mount - Class 1 SAE certified - 72"L x 12" W x 3 3/4" H

Don't forget the optional brackets!



Whelen 10" x 10" Lights  
P/N: MI 124002708



Whelen 16 Head LED light bar  
P/N: 50003036



Whelen 8 Head LED light bar  
P/N: MI 50003037

We also stock a variety of other pin styles!



### 4 Way Male Adapter

Replacement plug and socket

Heavy duty die cast replacement socket for tow lights or other accessories requiring a 4 way plug. Lighting end.

We Also Have 7 Pins in Stock

**P/N: 24-3P**



### 4 Way Female Adapter

Replacement plug and socket

Heavy duty die cast replacement socket for tow lights or other accessories requiring a 4 way plug. Truck end. We Also Have 7 Pins in Stock

**P/N: 24-3S**



### TowMate Carrying Case

Keep your light strip safe in this bag!

This carrying case is designed specifically for TowMate light strips. It will keep it protected, clean and scratch free! Ideal for your TM2.

**P/N: TM NCC-17**



### Magnetic Tow Lights

Most popular and affordable tow light made!

This set features two 4" Stop/Tail/Turn lights in a rubber housing to absorb road shock with magnetic bases and 30' of wire. Simply plug the 4 pin plug in your trucks 4 pin socket, put the lights on the disabled vehicle and your ready to go. 12VDC.

**P/N: CP HDTL30B**



### TowMate Rubber Boots

These heavy duty rubber boots are the perfect fit for your TowMate application

**P/N: TM MB100**

## Don't forget your cable!

### Heavy Duty Extension Cable

7 Way



CP EXT30-7PP

CP EXT30-4PP



4 Way

**P/N: CP EXT30-4PP**

**P/N: CP EXT30-7PP**



### Tow Light Boots (PAIR)

Protect your customers car with these!

Plastic boots for any magnetic towlight.

Protects against scratching or chips.

Sold in pairs.

**P/N: CP MB100**



### Tow Light Extension Cable

*Add extra length to your run...*

This 4 way extension cable features a male connector on one end and a female on the other to use in combination with your tow lights on a 4 way connector.

**P/N: CP EXT30B**



### Charge Cord

*Recharge your tow lights quickly*

This charge cord makes charging your tow lights quick and easy from a standard cigarette outlet. 12V DC.

**P/N: TM CC-STND**



### 7 Pin Transmitter

*Truck style transmitter*

This is a 7 pin truck style transmitter with round pins.

**P/N: TM 5007**



### Interactive Monitoring System

*Never lose your lights again!*

This interactive monitoring system (iMon) operates with any system equipped with iMon electronics. Plugs into 12V DC. Life-time warranty. 12V DC.

**P/N: TM-TMSR**



### Replacement Transmitter

*Replace your broken or lost transmitter...*

This TowMate transmitter will replace your lost or broken transmitter with no worry or fuss! Please give us a description of color wire you need when ordering

**P/N: TM 5004**



### Rechargeable Batteries

*Recharge your tow lights quickly*

Rechargeable sealed lead-acid batteries for TowMate wireless tow lights.

**P/N: TM-12V Batt TM-2**

**P/N: TM-6V7 Batt TM-36**



### Hardwire Transmitter for Towmates

*Standard hardwire transmitter*

Electronics are injection molded to resist the elements. For use with Towmate Wireless Lightbars

**P/N: TM-HWTX**



### Rocker Switch

*For Towmate Lighting Systems*

Easily control your non Powerlink lights with this switch. Install in your dash. This is not waterproof

**P/N: TM-SW-ROK**

## Wireless Tow Lights



### Green Wireless Tow Light

*Easy functioning light for all your towing needs.*

Tow light measures 22" and provides complete wireless stop, tail, turn signals. Mounts with two 90lb magnets and comes with a charge cord and 4 pin transmitter

**P/N: TM-TM22G-4**



### Wireless Tow Light

*Easy functioning light for all towing needs*

Tow light measures 21" and provides complete wire-less stop, tail and turn signals and four features on the opposing face. Mounts easily with two 100LB pull magnets. 12VDC.

**P/N: TM21S**



### Wireless LED Tow Light Strip

*Super slim design with full functionality!*

This tow light is a must have in every towers business. Simply plug the 4 way transmitter into your trucks 4 way socket, put the light in place and flip the switch, its that easy! Includes 90lb magnets and provides fully S/T/T light functions.

**P/N: TM2 w/ Marker Lights**



### 21" Wireless Tow Light

Light provides S/T/T. System features a solar panel for supplemental power increasing battery life reducing the need to charge.

**P/N: TMSP21**



### Wireless LED Tow Light Strip

*Durable housing means no cracking or rust!*

This wide load bar is the answer to all your problems. Equipped with a 7 pin transmitter, three 2" marker lights and 300 feet of wireless capability, this is a must have in your arsenal. Each charge is good for up to 20 hours and it's simple to use. Simply plug the 7 pin connector in your trucks 7 pin socket, strap on the vehicle, and flip the switch. 12 VDC. 6"H x 3 1/8"D x 36" L.

**P/N: TM36 36"**

**P/N: TM48 48"**



### Wireless LED Tow Light Strip w/ Monitor System

*Super slim design with full functionality!*

This tow light is a must have in every towers business. Simply plug the 4 way transmitter into your trucks 4 way socket, put the light in place and flip the switch, its that easy! Includes 90lb magnets and provides fully S/T/T light functions. Comes with monitoring system. Run up to 10 hours on a single charge with a range of up to 300 feet.

**P/N: TM21 w/ monitor system**

### TowMate Helios 38" Wireless Light with Lithium Technology

*long lasting lithium battery*

This new rechargeable, removeable, long lasting lithium battery is a game changer for the towing industry. With up to 22 hours of run time and up to 10 years life expectancy, this will be your go to light for years! Comes in a variety of pin styles, please mention style needed when ordering

**P/N: TM-HL38BUC**





### 2 Prong Pigtail Connector

This 2 prong male pigtail connector is made for LED clearance marker lights and includes a grounding wire pre terminated with a ring terminal.

**P/N: DC 8701**



### 2 Contact Pigtail Connector

This 2 contact pigtail connector plus is made for use with single or dual functioning lamps. It features 11" of lead wire.

**P/N: DC 8720**



### 3 Prong Pigtail Connector

This 3 prong right angle pigtail plug is made for use in standard sealed single contact lamps.

**P/N: DC 8710**



### Amber Reflector

Half moon amber reflector.

**P/N: AD CRK12A**



### Red Reflector

Half moon red reflector.

**P/N: AD CRK12R**



### Clearance Marker Light Bar

This clearance marker light bar is comprised of 3 marker lights wired together with 1 harness. Designed for mounting on the rear trailers to indicate a wide vehicle.

**P/N: MI 0311519**



### 3-Pin LED Load Equalizer

This 3-Pin LED load equalizer is used to allow LED use with standard flashers.

**P/N: MX M50905**

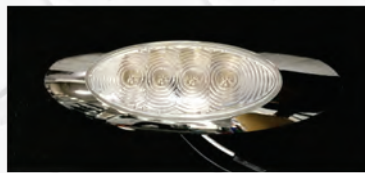

### LED Millennium Marker Lights

LED Millennium clear lens red and amber marker lights for carrier.

**P/N: MI 0312578**

**P/N: MI 0312580**

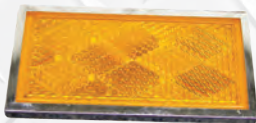

CV 93300A

CV 93300R



### Retangular Clearance Markers

Replacement rectangular clearance marker for Chevron brand trucks. 3 1/2" L x 1 3/4" H.

**P/N: CV 93300A**

**P/N: CV 93300R**



MI 0305969A

MI 0305969R



### Retangular Clearance Markers

Replacement rectangular clearance marker for Chevron brand trucks.

**P/N: MI 0308969A**

**P/N: MI 0308969R**

## Clearance Lights



MX M09100R  
MX M11300R



MX M09100Y  
MX M11300Y



MX M09100R/YCL  
MX M11300R/YCL



CV 94500R  
MI 0311512

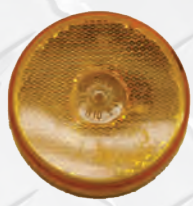

CV 94500A  
MI 0311513



CV 94500C  
MI 0311514  
MI 0311515

### Round LED Clearance Lights

*Brighter and more reliable*

Durable 2 1/2" or 2" round clearance lights. LEDs have long life than incandescent lights and also are much brighter in coverage. Grommet (mx m50-100B) fits 2 1/2" and (mx m50300-B) fits 2" light which are sold separately.

- P/N: MX M09100R            2"
- P/N: MX M09100Y            2"
- P/N: MX M09100R/YCL      2"
- P/N: MX M11300R            2 1/2"
- P/N: MX M11300Y            2 1/2"
- P/N: MX M11300R/YCL      2 1/2"

### Round Clearance Lights

*Cost effective and affordable*

Durable 2 1/2" or 2" round clearance lights. Chevron/Century/Vulcan OEM Led replacement lighting. Fits any 2 or 2 1/2" clearance hole. Please specify when ordering. Grommet (CV 93150) fits 2 1/2" and (MX M50-300B) fits 2" light. The grommets are sold separately.

- P/N: CV 94500R            2"
- P/N: CV 94500A            2"
- P/N: CV 94500C            2"
- P/N: MI 0311512/R        2 1/2"
- P/N: MI 0311513/Y        2 1/2"
- P/N: MI 0311514/RCL      2 1/2"
- P/N: MI 0311515/YCL      2 1/2"



MX M09300RCL/YCL



MX M09300R



MX M09300Y

### 3/4" Mini Combination Clearance Markers

*Superior LED lights around the size of a penny*

Tiny LED marker lamps which take up less space and measure 3/4" in diameter. Includes black grommet. Chrome grommet option sold separately.

- P/N: MX M09300R
- P/N: MX M09300Y
- P/N: MX M09300WCL
- P/N: MX M09300RCL

### 1 1/4" Combination Clearance Markers

*Superior LED lights around the size of a quarter*

LED marker lamps which take up less space and measure 1.25" in diameter. Includes black grommet.

- P/N: MX M09400Y
- P/N: MX M09400R



MX M09400Y



MX M09400R



MX M42213

JD 1000



CV 95500



MX M63150



MX M42324

### LED Back-Up Lights

*Durable and reliable extra life LEDs*

Sealed unit with rugged durability and 100,000 hour rated LED life. Available in rectangular, oval and round. Grommets sold separately.

**P/N: MX M42213**

**P/N: MX M63150**

**P/N: MX M42324**

### Incandescent Back-Up Lights

*Affordable and great quality*

Sealed incandescent back up light. Both the 4" round lens or oval lamp available. 4" Lens mounts in a standard 4 1/2" hole, Oval lamp is 6 1/2" L x 2 1/4" W.

**P/N: JD1000 (White)**

**P/N: CV 92600**

**P/N: CV 95500**

MX M49705



CV 96550

MX M63253CH



CV 92650

MX M50105



MX M50100-B

MX M50305



MX M50300-B



MX M50112

### Rubber Grommets

Rubber grommets used for any make of truck lighting.

**P/N: MX M50100-B**

**P/N: MX M50300-B**

**P/N: CV 96550**

**P/N: CV 92650**

**P/N: MX M50400-B**

**2 1/2"**

**2"**

**Rect**

**Oval**

**Round**

### Chrome Grommets

Chrome grommets used for any make of truck lighting.

**P/N: MX M50105**

**P/N: MX M50305**

**P/N: MX M49705**

**P/N: MX M63253CH**

**P/N: MX M50112**

**2 1/2"**

**2"**

**Rect**

**Oval**

**Round**



MX M50400-B





### Rectangular LED Stop/Tail/Turn

Stop/Tail/Turn featuring 44 LEDs measuring in at 5 1/4" L x 3 1/2" W. (cv 96550) grommet sold separately.

**P/N: MX M42201R**



### Rectangular Red Clear S/T/T

LED Red Clear stop/tail/turn light. 5.3" W x 3.4"H. Grommet sold separately.

**P/N: M42213RCL**



Mx M63100Y



Mx M63100R



Mx M63322RCL



Rectangular Park/  
Front/Turn. Also  
available in clear lens.

**P/N: MX 42213Y**

### LED Stop/Tail/Turn

These rugged S/T/T offer the highest durability and extra long life you can find. Grommets sold separately.

**P/N: MX M63100R**

**P/N: MX M63100Y**

**P/N: MX M63322RCL**

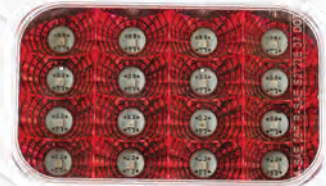

Miller Industries wrecker taillight

**P/N: MI 0311508**



### Round Stop/Tail/Turn

Stop/tail/turn light. 4" Round, 12 VDC.

**P/N: JD1000 Incandescent**

**P/N: JD1000LED LED**



### Rectangular Stop/Tail/Turn

Stop/tail/turn light. Measures 5 1/4" L x 3 1/2" W. Grommets sold separately.

**P/N: CV 96500 Incandescent**

**P/N: CV 96500LED LED**





# SAME DAY SHIPPING!

Ground Delivery | Next Day Delivery | 2 Day Delivery

GET THE PARTS YOU NEED...  
WHEN YOU NEED THEM!





Over 20 years, East Penn Truck Equipment has grown to two locations in PA to service all your equipment needs. Our team of professionals have many years of experience in the design and building of trucks that give you pride in our industry, not to mention we have two state of the art facilities to create and custom design the truck you're looking for along with quality products to match.

We also do custom paint work with our state of the art paint booths using Axalta paint products resulting in delivering the truck of your dreams.



## *Two Locations To Service You!*

**Eastern Division**  
1100 Win Drive  
Bethlehem, PA 18017  
800-432-5446

**Western Division**  
7298 W. Market St  
Mercer, PA 16137  
800-TILT-BED

Turn your dreams into reality...**TODAY!**

TWO LOCATIONS TO SERVE YOU!

Western Division  
7298 W. Market St  
Mercer, PA 16137  
800-TILT-BED

Eastern Division  
1100 Win Dr  
Bethlehem, PA 18017  
800-432-5446



**EAST PENN**  
TRUCK EQUIPMENT INC

*We can create and customize any design...*

Don't settle for anything less!



Eastern Division: 610-694-9234 | Western Division: 724-342-1800  
For pricing and availability, visit us online at: [www.eastpennpartsonline.com](http://www.eastpennpartsonline.com)

# THE RIGHT CHOICE, EVERY TIME

PROVIDING THE FINEST BUILT MILLER INDUSTRIES TOWING EQUIPMENT IN THE U.S.

- **In-House Fabrication & Engineering**
- **Custom Installations**
- **Restorations Services**

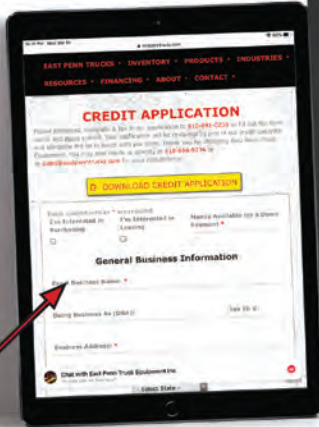

**Financial Services**  
Use our instant online credit application and take the next step toward obtaining your financing needs



**Browse Our Inventory**  
Search by new vehicles, used vehicles, chassis and specialty inventory



**Truck Brochures**  
Find brochures on the latest truck models from all manufacturers

[www.eastpenntrucks.com](http://www.eastpenntrucks.com)



**GIVE OUR SALES PROFESSIONALS  
A CALL TODAY TO GET THE LATEST  
INCOMING CHASSIS INVENTORY!**

**BETHLEHEM 610-694-9234  
724-342-1800 MERCER**



**NOW AVAILABLE AT EAST PENN**



**Hook Lift Trucks - 100 Series Hook Lifts  
7,500-20,000 LB. Capacity**



**Hook Lift Trucks -200 Series Hook Lifts  
22,000-24,000 LB. Capacity**



**Hook Lift Trucks 400 Series Hook Lifts  
33,000-40,000 LB. Capacity**



**Heavy Duty Series Hook Lifts  
54,000-65,000 LB. Capacity**

**NOW AVAILABLE AT EAST PENN**

An EFCO Company

**SWAPLOADER<sup>®</sup>**

U.S.A. LTD.

*"Hooked on Quality"*



### In The Ditch X-Series Dollies

The new innovative X-Series dollies from In The Ditch offer two choices to best fit your needs.

#### Automotive Grade DOT approved Extended Life X-Series sealed hub

The only DOT approved hub in the entire world! These dollies are very little maintenance, no more greasing your hubs to make sure they are ready to perform. Just routinely check the dollies before use, it is that simple!

#### Speed Lube X-Series Lubrication

The Speed Lube X-Series allows for easy lubrication with a conveniently located Zerk fitting. It has never been easier to lube the dollies for use!

What do these dollies have to offer?

- 2 choices in tire size load capacity - SD (3,040LB) or XD (4,000LB)
- Ergonomic design for easy handling
- 2 breakover bar insertion points allowing for the ability to roll the dolly
- Bolt on replaceable spindles
- Easy to use camlocks
- Two hub designs
- Available in both black coated finish or zinc-plated



#### Speed Lube Series -

**SLX-SD Black Powder Coat - ITD2878**

**SLX-SD Zinc Plated - ITD2878-P**

**SLX-XD Black Powder Coat - ITD2890**

**SLX-XD Zinc Plated - ITD2890-P**



#### Extended Life Series -

**XL-SD Black Powder Coat - ITD2778**

**XL-SD Zinc Plated - ITD2778-P**

**XL-XD Black Powder Coat - ITD2790**

**XL-XD Zinc Plated - ITD2790-P**

# In The Ditch Speed Dollies

# TOWING EQUIPMENT

## East Penn Exclusive Dolly Basket

This dolly storage basket is an East Penn exclusive product! The basket holds dollies, break over bar, axle tubes and straps in one convenient location. It has never been easier to transport your dollies on your carrier!

**Sold Individually.**

**P/N: EPdollybasket**



**BEST BUY!**



## Integrated Speed Mount

This all in one speed dolly storage mount makes transporting your dollies a snap. Each speed mount holds a single dolly, axle bar and break over bar. Comes with lock and key for security.

**Sold Individually.**

**P/N: ITD 1349**



## Locking Simple Mount

The Locking Simple™ Mount is a basic, cost-efficient dolly mount. The Simple™ Mount is built to snugly fit the frame of a Speed® Dolly and mounts securely to the deck of a wrecker.

**Sold Individually.**

**P/N: ITD 1564**

**P/N: ITD 1561**

**P/N: ITD 1555 SHORT STYLE**



## Modular Speed Mount

This mount is a solution to mount your speed dollies on a composite body. With an adjustable dolly cradle, this will accommodate many composite body styles.

**Sold Individually.**

**P/N: ITD 4665L**

**P/N: ITD 4665R**

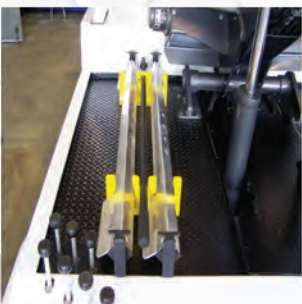

## Double Axle Rack

This lockable axle storage rack holds two aluminum telescoping axles and a lightweight break over bar. The break over bar is cradled between the two axles and is held in place with a thumb screw system. The double axle rack consists of two pre drilled pieces that install quickly and easily.

**Sold Individually.**

**P/N: ITD 1027**



## Carrier Dolly Mount

Store your In The Ditch Speed Dolly on your car carrier! Sold individually

**Sold Individually.**

**P/N: ITD 1347**



### Telescoping Aluminum Axles

*Light weight axle tubes*

New Style In The Ditch 4th generation telescoping axles tubes for all X-Series dollies. Sold Separately

**P/N: ITD 1751**



### Dolly Tires and Rims

*Replace damaged tires easily!*

Replacement tires, rims or complete tire assemblies are available for any make of dolly.

**P/N: ITD 7009** 4:80x8 Tire only

**P/N: ITD 7093** 5:70 x 8 tire only

**P/N: ITD 7094** 8" Alum wheel

**P/N: ITD 7096** 5:70 x 8 Alum wheel/tire

**P/N: ITD 7098** 4:80 x 8 Alum wheel/tire



### Stainless Steel Snap Button

Custom snap button for Speed Dolly aluminum telescoping axles.

**P/N: ITD-7008**



### Replacement Breakover Bar

*Lightweight bar!*

Replacement breakover bar for In The Ditch dollies. Bar only weighs 8lbs!

**P/N: ITD 1452**



### Dolly Ratchet Strap

Replacement dolly ratchet strap for speed dolly. 2 needed for dolly set.

**P/N: ITD-1344**



### Dolly Mount Locks

*Replaceable locks for your "In the Ditch" dolly*

Replacement vise locks for In The Ditch dolly mounts.

**P/N: ITD 7020**

### Swing Arm Mounts

Easy storage solution for dolly breakover bar and axle tubes. Quick mounting in back of pick up, on top of a toolbox or on a wrecker deck. Can use a padlock with this mount system, sold as a set.



**P/N: ITD-1242**



### Dolly Bunk Set

*Fit all sizes and brands of dollies!*

Set includes two complete dolly bunks and two lockable retaining chains.

**P/N: ITD 1023**



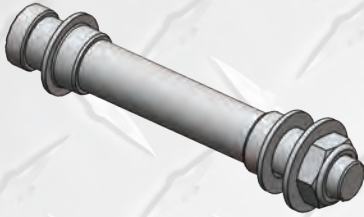

**Dolly Pin Kit**  
Includes:  
1- 1/2" SS Washer  
1- 1/2" Nut  
1- ITD 7377  
2- ITD 7379

**P/N: ITD 7394**



**Replacement Bearing**

*The answer for damaged or broken bearings!*  
The following are accessories to fix broken or damaged bearings.

- P/N: ITD 7011 Grease Seal**
- P/N: ITD 7112 Bearing**
- P/N: ITD 7013 Dust Cap**
- P/N: ITD 7118 1" Bearing and Race**
- P/N: ITD 7119 1" D washer**
- P/N: ITD 7120 1" Jam Nut**
- P/N: ITD 7121 1" Nut Retainer**
- P/N: ITD 7122 2" SLX Dust Cap**
- P/N: ITD 7123 2" SLX Dust Cap Plug**



**Complete Hub Assemblies**

*"Fast and Easy Replacement"*  
Complete hub assembly for the In The Ditch dollies. Replacement is quick and easy! In The Ditch Replacement sealed hub bearing kit for the X-Series Dollies

**P/N: ITD 7357**



**Complete Hub Assemblies**

*"Fast and Easy Replacement"*  
Complete hub assembly for the In The Ditch dollies. Replacement is quick and easy! In The Ditch Replacement sealed hub bearing kit for the X-Series Dollies

**P/N: ITD 7003**  
**P/N: ITD 7395**

**GO JAKS MODEL 5000/6000**

Allows 1-2 people to move a car freely. This combination jack/dolly will let you lift and move a locked, blocked or disabled vehicle by hand in just a few short seconds. Prevents damage to oil pans and ground effects. Rated at 1,250lbs each and accommodates 13" to most low profile 16" wheels up to 9" wide. Gojaks will not replace towing dollies but do allow you to have the ability to position vehicles by hand.

**P/N: WTD GJ5000 MODEL 5000 1250lbs rated**  
**P/N: WTD GJ6000 MODEL 6000 1550 lbs rated**



## GO JAK Mounting Brackets



**Go Jak Holders (Pair)**

Steel mounting brackets to hold two GoJaks of any size. Mount to any flat surface and be ready to go in minutes! Sold in pairs!

**P/N: AD-GJ101**



**GO JAK Holders**

Universal locking Go Jak bracket. Securely hold GoJak in place with ratchet teeth. Add your own padlock for added security

**P/N: AD GJ108**

# TOWING EQUIPMENT

## Truck Equipment



**PTO Cable**

All makes and models of equipment.  
Vertical stand cable that provides smooth operation.  
Available in multiple sizes.

- P/N: BP-R04D4-5X06** 6' Long
- P/N: BP-R04D4-5X10** 10' Long
- P/N: BP-R04D4-5X20** 20' Long



**Spreader Bar**

Designed for use in all types of heavy through light duty lifting applications, this unique spreader bar allows for executing straight vertical lifts without damaging or collapsing the sides of the casualty. (sold individually)

**P/N: MI 124004417**

Don't Forget Mounting Brackets to Properly Secure Your Spreader Bars!

**P/N: MI 124004426**



**Wheel Chock**

Durable, heavy-duty rubber construction! Rubber wheel chocks are designed for durability and ease. Wheel chocks sold separately.

**P/N: BP WC1086UWH**



**Container Skates**

Moving heavy objects is much easier when using container skates

- P/N: 48-CSP6** Skate with plug
- P/N: 48-CSP5** Low profile skate

**Throttle Cable**

Control the idle from the cab!  
Weatherproof handles cable keep the weather at bay. Turn knob to raise idle or push button to release it.  
Adjustable locking control.



- P/N: 13-1A** 6' Long
- P/N: 13-1** 10' Long
- P/N: 13-2** 15' Long
- P/N: 13-3** 20' Long



**Spreader Bar Rigging Kit**

Kit includes three 1 1/2" screw pin shackles, two 1 1/4" screw pin shackles, two orange 5 foot straps and two blue 10 foot straps.

**P/N: MI 124004724**

**Tire Skates**

Easily slide along any surface.

Wedge the skate under a vehicle and it will slide along without sticking. Great for loading on to carrier beds or positioning a vehicle behind your truck prior to hook up. Each set includes 4 skates.

**P/N: 48-1**



**Wreckmaster Interlocking Tire Skates (NEW STYLE)**

**P/N: 48-701135**

### Starter Frame Forks

Axle fork kit from Miller Industries have a 2" wide opening. Sold in pairs

**P/N: MI 124004454**



### Aluminum Tire Stand

This aluminum stand is the safest way to support tires for fork placement. It allows you to avoid injuries and provides a solid, stable base. Lifts 6" from the ground. 6,000lb rating each, 12,000lb rating per pair.

**P/N: ITD 1132**



### Speed Chock Kit

Never get frustrated with chock again with the In The Ditch Speed Chock Kit. These chocks easily anchor. These mounts are pre drilled for easy installation.

**P/N: ITD 1010**



### Lug Wrench Bracket

Keep your tool box organized with this lug wrench bracket. Lug wrench bracket holds up to 2 lug wrenches. Bracket is made from aluminum.

**P/N: ITD 1110**

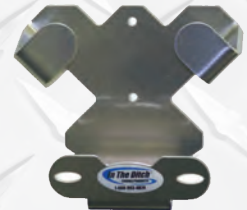

### Chevron Tow Bar Adapter Bracket w/ Mount Bracket

This mount is designed to hold the Chevron autogrip tow bar adapter. Comes with pre-drilled holes & can be locked.

**P/N: ITD 1111**



### Alloy Scotch Block

Used for light to heavy duty towing. The alloy scotch blocks are lightweight and weigh only 19lbs. 7" W x 10.25" L x 8.13" H

**P/N: ITD 1096**

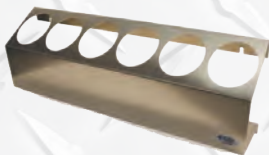

### Aerosol Can Mount

This aluminum aerosol can mount is the solution for storing multiple aerosol cans. Bolts to any flat surface.

**P/N: ITD 1020**

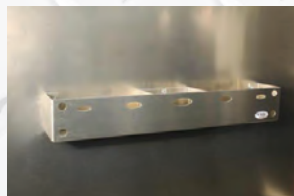

### Shelf with Removable Divider

This aluminum storage shelf keeps your truck organized and clutter free. Dimensions are 21" x 3" x 3" and contains a removable divider.

**P/N: ITD 1103**

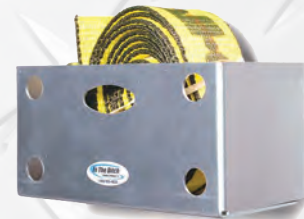

### Mountable Shelf

This aluminum storage shelf keeps your truck organized and clutter free. Dimensions are 6" x 3" x 3".

**P/N: ITD 1106**

# TOWING EQUIPMENT

## Truck Equipment



### Rubber Clamps (PAIR)

Quick fist clamps for any application  
Grips up to 25lbs per clamp and from 5/8" to 1 3/8" diameter. Attach with industrial adhesive or with bolts.

**P/N: BP RC10S Small**  
**P/N: BP RC10L Large**

### Universal Spring Tube

This is a great place to attach the hook on a winch line when not in use. 3 Different mounting options for hundreds of applications.

**P/N: ITD 1196**



### Fold-Out Retractable Ladder

Measuring 15' tall when fully extended, the collapsible ladder can be easily compressed for in-truck storage. For use in the field, the ladder has a maximum weight capacity of up to 330 pounds and it is CE-and OSHA approved.

**P/N: MI 124004656**



### Sling Straps (PAIR)

Fits all popular brands and models

**10" x 47" 4 Hole P/N: 1-1**

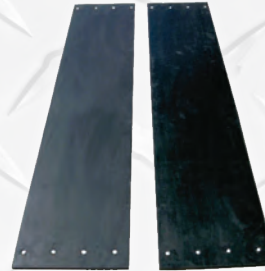

### Heavy Duty Shovel

This shovel has a large blade and is strong enough for the toughest road side clean ups.

**P/N: AD RC1B**

### 2 Piece Shovel

This easy to store shovel collapses down to 24" L. Blade measures 10"W x 12"H.

**P/N: AD RC40**



### Heavy Duty Broom

Plow through the toughest sweeping loads with this heavy duty broom w/ medium bristle & telescoping handle.

**P/N: AD BRK18A**



### Dust Pan

This aluminum dust pan is designed for road side clean up.

**P/N: AD SDP**



### XD Extreme Duty Trash Can Holder

**P/N: ITD1374**



### Steel Trash Cans

Hold the mess without using much truck space. Comes with removable lid. Made of galvanized steel.

6 Gallon - 12 1/2" D x 14 1/4" H

**P/N: ITD 1087 6 Gallon**

### 5 Gallon Gas Can Mount

Fits all gallon gas/diesel cans. Easy to mount with four 5/16" bolts. Made from aluminum.

**P/N: ITD1091**

### 6 Gallon Wrecker Trash Can Mount

Fits 6 gallon trash cans. Mounts easily with pre drilled holes that fit easily to Pro Series tool boxes.

**P/N: ITD 1054**

**C.A.R.B.**  
Compliant

### 5 Gallon Cans

**P/N: ITD7041**



Gas



H<sub>2</sub>O



Diesel



## Easy Glow Lockout Kit

*Everything you need in one kit!*

This package is equipped with a 4½' reach tool, non marring plastic wedge, plastic paint protector and lock knob strip tool.

**P/N: ST 32955**



## Easy Wedge Tool

Versatile mini wedge slips apart tight weatherstripping. 5¼"L x 1"H

**P/N: ST 21730**



## Inflatable Wedge

*One button release*

This simple one button release valve wedge is great for anyone! just slip the flattened wedge into the door frame and inflate.

**P/N: ST 32922**

**P/N: ST 32923**



## Easy Wedge Tool

Big Easy non marring wedge.

6½"L x 3¼"W

**P/N: ST 32920**



## Big Easy Loop

*Lockout easier to handle with loop*

Loops snaps on easily to BigEasy and provides easier leverage to pull handles open. it is made from tough material to provide strength and flexibility. This tool makes lockouts fast!

**P/N: ST 32903**



## Easy Lock Out Tool

Big Easy lock out tool. Glow in the dark tool idea for all types of vehicles.

4½" Tool

**P/N: ST 32915**



## Big Easy Extend

*Reach easier with this extender!*

The Big Easy Extend simply connects to the Big Easy. It can easily grab things across the vehicle and can also easily reach the hood release latch on most vehicles.

**P/N: ST 32905**



## 29" Little Easy Lockout Tool

**P/N: ST 32908**



## Big Easy Carrying Case

*Convenient pocket for all your tools!*

The Big Easy carrying case features a long compartment and a smaller compartment for all your carrying needs. Also has Velcro and snaps to reduce chance of tools being lost. Tools sold separately.

**P/N: ST 32935**



## Big Easy Paint Protector

*Easy and quick to use!*

The Big Easy Paint Protector is a must have when dealing with lock outs! Reduces friction between the car door and the Big Easy which minimizes powder coating from rubbing off.

**P/N: ST 32924**



Plastic tip for Steck Big Easy long reach door tool

**P/N: AD1426004**

# TOWING EQUIPMENT

**Access Tools™**  
"The undisputed leader in specialty tools"



Smart Light  
P/N: AT ASL



Wedge Wedgie With Strip Savers Attached  
P/N: AT WEDGEE



Access Tools Replacement Tips for Long Reach Tools  
SOLD ONLY BY DOZEN  
P/N: AT SNG-TIPS

Air Wedge Repair Kit  
P/N: AT AW-RPK



Flat Max Long Reach Tool  
The product features a loop tip, hook tip and is 60 inches long.  
P/N: AT ACT-FMT

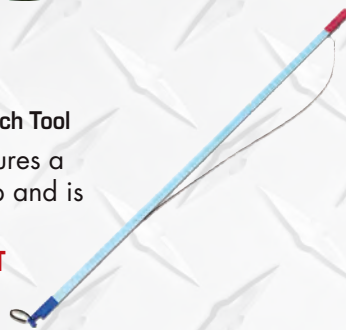

Long Reach Remote Control Button Master  
P/N: AT RCBM



Heavy Duty Long Reach Remote Control Button Master  
P/N: T RCBMHD



Spare Tire Kit  
P/N: AT STK2



Air Wedge  
P/N: AT AW

Long Reach Lightning Rod  
P/N: AT LR



Strip Savers  
P/N: SS



Emergency Response Kit  
P/N: AT ERK



One Hand Jack Set  
P/N: AT OHJS4

# In The Ditch Speed Dollies

# TOWING EQUIPMENT



### Booster Cable Assembly

High quality jump start kit that will be sure to jump start disabled vehicles quickly and safely. 500 amps.

**P/N: PH JM30**

### Set Includes:

30' of 4 gauge copper wire  
Removal handles  
All necessary hardware  
and dust cap

## Heavy Duty Truck Wheel & Hub Covers

### Rear Replacement Hubcover

For use with aluminum wheels. Made from rugged stainless steel and polished to a mirror bright finish. Installation is quick and easy and does not require lugnut removal unless noted.

#### Medium trucks with 8 lug wheels

(2.88" hex bolt length, 6.25" hub diameter)

**P/N: PH Q1009**

#### Medium trucks with 10 lug wheels

(2.88" hex bolt length, 6.25" hub diameter)

**P/N: PH Q2010**

#### Heavy trucks with 10 lug wheels

(2.88" hex bolt length, 8.25" hub diameter)

**P/N: PH Q2020**

### Front Hub Caps

Traditional halfmoon shape front hub cap. Hubs fit securely and easily with snap on feature. Clips included.

**P/N: PH Q1401 4 spline**

## ADDITIONAL ACCESSORIES



Booster Plug Connector  
500 Amps battery clamps

**P/N: AD GL8**



Replacement Plug Eng

**P/N: PH PJM30PC**



Booster Plug Cover  
Plug cover with lanyard

**P/N: PH PJM30DC**

## MAXIMIZE YOUR SAFETY

Don't Forget  
the Cone Holder!



Deck Mounted Cone Holder  
**P/N: ITD-1180**



### Traffic Cones

This durable cone maintains its brightness and flexibility. Meets MUTCD and NCHRP-350 requirements.

**P/N: AD TCG28N**



### Triangle Reflector Kit

Collapsible, reflective triangles feature weighted bases, which allow them to rotate 1/4 turn and stay upright.

**P/N: 26-3**



Fire Extinguisher  
2.5 LB DOT Fire Extinguisher

**P/N: AB 1696423C2**

Eastern Division: 610-694-9234 | Western Division: 724-342-1800  
For pricing and availability, visit us online at: [www.eastpennpartsonline.com](http://www.eastpennpartsonline.com)

# TOWING EQUIPMENT

## Roadside Assistance



**Jump and Carry**  
Jumper pack with  
12 VDC. 450 cold  
-cranking amps.

**P/N: WTD-JNC660**

**Vanair / Goodall Start**  
All products and equipment.  
Call for more information and  
pricings.



**Goodall 5,000 Amp  
12 Volt Jump Starter**

**P/N: VNA 12-5000**



**Goodall 10,000 Amp 12  
Volt Jump Starter**

**P/N: VNA 12-10000**



**Goodall 2,500 Amp  
12 Volt Jump Starter**

**P/N: VNA 12-2500**



**Left Tail Light Bezel  
P/N: CV 0721760L**



**Left Light Mounting Plate  
P/N: CV 0720030**



**Left LCG Tail Light Bezel  
Fits 12/16/20 Series  
P/N: CV 196152L**

**For more tail light  
housing options  
give us a call**



**Right Tail Light Bezel  
P/N: CV 0721760R**



**Right Light Mounting Plate  
P/N: CV 0720031**



**Right LCG Tail Light Bezel  
Fits 12/16/20 Series  
P/N: CV 196152R**

**Left Tail Light Housing  
P/N: CV 0809517L**



**Right Tail Light Housing  
P/N: CV 0809517R**



**Left 6 Spool Control Panel  
Gen II**

**P/N: CV 0762652L**



**6 Spool Control Hood  
Gen II**

**P/N: CV 0752651**



**Right 2 Toggle Air Valve  
Control Panel**

**P/N: CV 18148R**



**Right 6 Spool Control Panel  
Gen II**

**P/N: CV 0762652R**



**Left 2 Toggle Air Valve Control  
Panel**

**P/N: CV 18148L**



# Replacement Parts

# TOWING EQUIPMENT



L-Arm Scoop Pan  
P/N: CV 65245  
\$41.78

### Chevron L-Arm

Chevron L-Arm for Series 10,14,20 car carriers & Chevron 408 and 410 wreckers. *Scoop pan sold separately*

P/N: CV 65250R Passenger  
P/N: CV 65250L Drivers



L-Arm Scoop Pan  
P/N: CV 65245  
\$41.78

### Chevron L-Arm

Chevron L-Arm for LMD/510/512 wreckers. *Scoop pan sold separately*

P/N: CV 66250R Passenger  
P/N: CV 66250L Drivers



### Miller L - Arm

Replacement Miller L-Arm. Fits Vulcan & Century trucks.

P/N: MI 08006748



### Miller Replacement Retainer Scoop

Vulcan 4,000lb L-arm used with the 880 series and most Vulcan/Century carriers.

P/N: MI 8700180 Passenger  
P/N: MI 8700190 Drivers



### Miller Replacement Retainer Scoop

Vulcan 6,500lb L-arm used with the 896 series.

P/N: MI 896390000 Passenger  
P/N: MI 896397000 Drivers

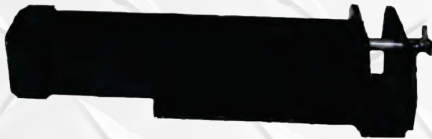

### Chevron 3 1/2" Wheel Grid

This chevron 3 1/2" replacement wheel is used on the following models; Series 10, 14, 20 car carriers and Model 408/410.

P/N: CV 65265R Passenger  
P/N: CV 65265L Drivers

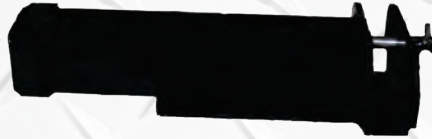

### Chevron 4" Wheel Grid

This chevron 4" replacement wheel is used on the following models; 510/512/LMD wreckers.

P/N: CV 66260R Passenger  
P/N: CV 66260L Drivers

Contact us for all Jerr-Dan replacement parts!

**JERR-DAN**



### Miller Wheel Grid Assembly

Compleat Vulcan wheel grid assembly. Right hand, stop pin and plunger inc.

*Fits 804, 860, 870,880 and most carrier models*

P/N: MI 8800800 Passenger  
P/N: MI 8800900 Drivers



### Miller Wheel Grid Assembly

Compleat Vulcan wheel grid assembly. Right hand, stop pin and plunger inc.

*Fits 850,896 & 897 models*

P/N: MI 124008001 Passenger  
P/N: MI 124008002 Drivers



### Miller Standard Grid Assmebly

Complete miller wheel grid assembly. Use wheel retainer # 0801332 for use with this wheel grid.

P/N: MI 0909498R Passenger  
P/N: MI 0909498L Drivers

# TOWING EQUIPMENT

## Replacement Parts



### Fork

Chevron forks available in both 2", 3" or 4" configurations.

**P/N: CV 66300 3"**

**P/N: CV 66310 4"**



### Fork Holder Adapter

Chevron fork adapters available in both 3 1/2" or 4" configurations.

**P/N: CV 66280 3 1/2"**

**P/N: CV 66280 4"**



### 5"x5" Left Fork Adapter

**P/N: MI 0803591**



### 5"x5" Right Fork Adapter

**P/N: MI 0803592**



**MCI Bus Lift Eye Attachment**  
"Easy to hook up a bus with this attachment"

**P/N: MI 124002634**



### Spacer Kit

Cast fork

**P/N: MI 124002430**



### Volvo Fork Kit

**P/N: MI 124002614**



### U-Bolt Adapter

Quick easy way to lift vehicles from rear suspension.

**P/N: 124002632**



### Spring Shackle Adapter

Easy hook up on leaf springs.

**P/N: CV66320**

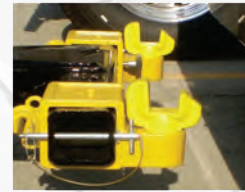

### Axle Fork Kit

Features include a shorter front leading fork, a tighter distance between the forks, and a wide design to prevent sliding.

**P/N: 124004454**



### 5th Wheel Power Hitch

Universal fit allows this hitch to be used on different trucks!

**P/N: ITD 1253**



### Autogrip Tow Ball Adapter

**P/N: CV 694510G**



### Pintle Hitch Attachment Group

**P/N: CV 66370G**



### Crossbar Chain Hook Adapter

Miller chain hook adapter, sold by the pair.

**P/N: 124001420 5"**

**P/N: 124002048 4"**



### Forklift attachment

Chevron Auto-Grip II Forklift attachment.

**P/N: 60530112K**

# Replacement Parts

# TOWING EQUIPMENT

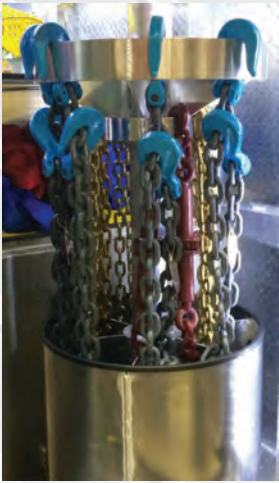

**Vulcan Rotating Chain Rack**  
Used in combination with a 36" or 48" tunnel box

**P/N: MI 50004944**

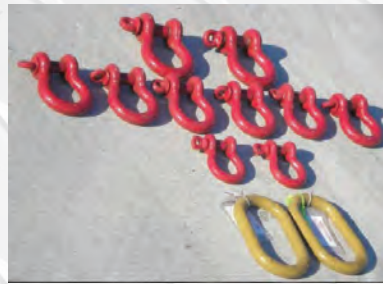

### Alloy Screw Pin Shackle Kit

The kit includes the following:

- Two 1 ¼" alloy master links 18 ton
- Two 1" alloy screw pin shackles 8 ½ ton
- Six 1 ¼" alloy screw pin shackles 12 ton
- Two alloy screw pin shackles 17 ton.

Made in the USA!

**P/N: MI 124004083**



### Medium Duty Endless Loop Sling Kit

The kit includes the following: 4 foot and 6 foot yellow sling and an 8 foot and 12 foot blue sling

**P/N: MI 124004521**



**A/C Inverter Kit (HD)**  
1000W

**P/N: MI 50003236**



### 5th Wheel Adapter

For heavy duty wreckers.

Pintle only

**P/N: 124001833**

Pintle and 5th Wheel

**P/N: 124002645**



### Endless Round Sling Kit

The kit includes the following: 4 foot and 6 foot yellow sling, 8 foot and 12 foot red sling and a 12 foot and 16 foot blue sling

**P/N: MI 124002697**



### HD Chain Kit

The kit includes the following:

- Two grade 80, 5/16"x10' chains with cradle grab hooks
- Two grade 80, 5/16"x20' chains with cradle grab hooks
- Two grade 80, 3/8"x10' chains with cradle grab hooks
- Two grade 80, 3/8"x20' chains with cradle grab hooks
- Two grade 100, 1/2"x 10' chains with non-cradle grab hooks
- Two grade 100, 1/2"x20 chains with non-cradle grab hooks
- Two grade 100, 1/2"x 5' chains with non-cradle grab hook on one end
- Two grade 100, 5/16"-3/8" ratchet binders

**P/N: MI 124004661**

### LED Air Guard Kit

Use this kit to monitor tire pressure

**P/N: MI 03005651**





Aluminum Chain Lock - 2 Way

P/N: CV 31810



Aluminum Chain Lock - 1 Way

P/N: CV 318101



Aluminum Chain Lock - 4 Way

P/N: CV 318104



Aluminum Gen III Chain Lock - 2 Way

P/N: MI 07001617



Chevron Wheel Spacer

Commonly used on Chevron auto grip wheel lifts. Lock with T-pin. CV-84921K - Tpin sold separate.

P/N: CV 69740L Drivers

P/N: CV 69740R Passenger



Chevron Body Lock Ear

Body lock ears. Comes complete with angle bracket, wheel and all hardware. This is a complete kit.

P/N: CV 36315KL

P/N: CV 36315KR

P/N: CV 36315L Ear Only

P/N: CV 36315R Ear Only



Chevron Body Lock Replacement Wheel

P/N: CV 36310



Chevron Body Lock Angle Weldment

P/N: CV 364002

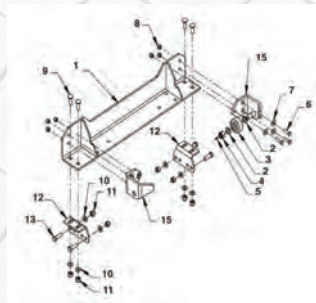

Body Lock Assembly - 10 to 20 Series

Complete body lock assembly for 10 to 20 series bodies. Comes with weldment, both left and right ears, wheels and hardware.

P/N: CV 36400K

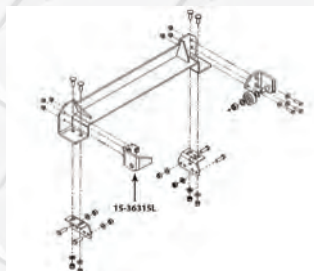

Body Lock Assembly - All LCG

Complete body lock assembly for LCG bodies. Comes with weldment, both left and right ears, wheels and hardware.

P/N: CV 364220K

# Chevron Replacement Parts

# TOWING EQUIPMENT

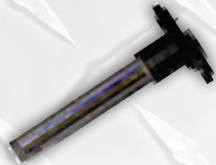

### Chevron T-Pin w/ Lanyard

Chevron wheel lift T-pin. Use with Chevron series 10 - 20 carriers & 408/410 wreckers.

**P/N: CV 84921**

**P/N: CV 84922K** 12-16 ton wreckers



### Chevron Wheel Grid Cam Lock

Chevron style cam lock. Used for Chevron style wheel lifts only.

**P/N: CV 88131** 3 3/8"

**P/N: CV 88132** 4 3/4"



### Miller Scoop Brasket Assembly

Replacement miller scoop assembly. Includes lock pin w/ chain.

**P/N: MI 8701500** Passenger

**P/N: MI 8701600** Driver



### Miller Scoop Brasket Assembly

Replacement miller scoop assembly. Includes lock pin w/ chain.

**P/N: MI 896387500** Passenger

**P/N: MI 896380500** Driver



### Miller Stop Pin Assembly

Replacement miller Pin assembly.

**P/N: MI 880411600**



### Lock Pin w/ Chain

Replacement lock pin w/ chain for scoops.

**P/N: MI 8621900**



### Chevron Control Handle

Replacement handle for Chevron carriers.

**P/N: CV 7A111**



### Chevron Control Handle

Replacement handle for Chevron Knuckle carriers.

**P/N: CV 7A1160** Blue

**P/N: CV 7A1160** Gray

**P/N: CV 7A1160** Green

**P/N: CV 7A1160** Red

**P/N: CV 7A1155** Knuckle



### Chevron Control handle Knuckle

Replacement control handle pivot base for new style Chevron control handles

**P/N: CV 7A1155**



### Replacement Gresen Valve Stem

Attaches to valve body.

**P/N: CV 7A010-1**



### Replacement Bell Crank

Bell crank that attaches to valve body.

**P/N: CV 7A121**



### Carrier ID Panels

Replacement control panels for carriers

**P/N: CV 18214R** 10-16 Series

**P/N: CV 18214L** 10-16 Series

**P/N: CV 18218R** 4 Car Series

**P/N: CV 18218L** 4 Car Series



### Control Rod Clevis

Replacement clevis for Chevron brand.

**P/N: CV 84540** Left

**P/N: CV 84530** Right



### Chevron Pin & Link Assembly

All you need to replace your dirty pins.

**P/N: CV 7A010**

# TOWING EQUIPMENT

## Replacement Parts



Chevron Decal  
P/N: CV AA021



Renegade Decal  
P/N: CV AA032



Vulcan Decal  
P/N: CV AA032



Century Decal  
P/N: CV AA032



Clevis Pin  
P/N: CV 84620



Quick Pin for  
Removable Rails  
P/N: CV 84911



Safety Pin 7/16"  
P/N: CV 84714



Aluminum T Handle  
P/N: MI 0306564



Pin Assembly  
P/N: MI 0900900



Gresen V12 Valve  
Stem Extension  
P/N: CV 7A011



T Handle  
P/N: CV 12614

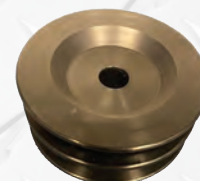

Small Sheeve  
2 Grooves  
P/N: MI 810040004



Chain Basket 2 way,  
bolt on  
P/N: CV 08007268



Chevron Self Centering  
Plate  
P/N: CV 6i1712



Anti Tilt Bracket Gen II  
P/N: CV 33813



Miller Center Plate  
P/N: MI 0718217



Chevron Mud Flap Bracket  
All in board tilt mudflap bracket.

P/N: CV 12350L Drivers  
P/N: CV 12350R Passenger  
LCG Version  
P/N: CV 0751024L Drivers  
P/N: CV 0751024R Passenger



Chevron Storage Bracket  
Pivoting L-Arm storage bracket  
mounted to stabilizer. For carriers.

P/N: CV 160530L Drivers  
P/N: CV 160530R Passenger

# Replacement Parts

# TOWING EQUIPMENT



**Screw In Plug**  
Used in Autogrip crossbar.

**P/N: CV 64327**



**Detent Spring**  
Used in Autogrip crossbar.

**P/N: CV 69320**

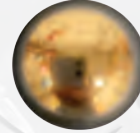

**Detent Ball**  
Used in Autogrip crossbar.

**P/N: CV 69325**



**Autogrip Chain**  
Used in Autogrip crossbar.

**P/N: CV 87440**



**Chain Attachment Block**  
Used in Autogrip crossbar.

**P/N: CV 64444**



**Hex Nut Weldment**  
Used in Autogrip crossbar.

**P/N: CV 64436**



**Clevis**  
Used in Autogrip crossbar.

**P/N: CV 64441**



**Short Whip Hose**  
Used in Autogrip crossbar.

**P/N: CV SIHYT25105**



**Internal Autogrip Hose 10.5"**

**P/N: CV SIHYT251055**



**Internal Autogrip Hose 6.5"**

**P/N: CV SIHYT2565**

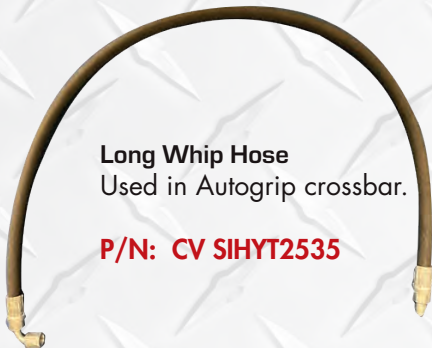

**Long Whip Hose**  
Used in Autogrip crossbar.

**P/N: CV SIHYT2535**



**Replacement Coil V-20**

**P/N: CV 74111C**



**Hose Track**  
Renegade Wrecker, Autogrip II.

**P/N: CV 69726**

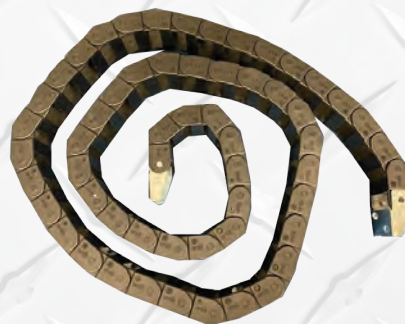

**Hose Track**  
Series 10/12 Chevron car carrier,  
Autogrip.

**P/N: CV 69757**



**Hydraforce 12V Coil**

**P/N: MI 0311341**



**Anti Tilt Rod**  
Bolt on. 6 3/4".

**P/N: CV 0809904**



**Saddle Pin**  
Shaft and base end. 1.230" diameter x 6 1/4" length.

**P/N: CV 1A735**



**Upper Tilt Pin**  
Series 10/14.

**P/N: CV 13068**

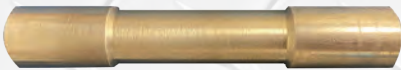

**Wheel Lift Boom Extension Rod End**  
6" length x 1" diameter.

**P/N: CV 643572**



**Crossbar Pivot Pin**  
Used in Autogrip crossbar.

**P/N: CV 64440**



**Crossbar Pivot Pin**  
Used on 512.

**P/N: CV 66430**



**Low Profile Center Pin**  
Used in Autogrip crossbar.

**P/N: CV 644402**



**Autogrip II Cylinder Pin**  
Gen II.

**P/N: CV 644432**



**Pivot Pin**  
Used in Autogrip II crossbar.

**P/N: CV 644452**

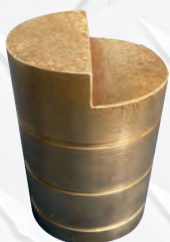

**Crossbar Pivot Pin Assembly**

**P/N: CV 65430**



**Crossbar Pivot Pin Assembly**

**P/N: CV 0940433**



# Replacement Parts

# TOWING EQUIPMENT



**Pin Assembly for Crossbar**  
5/8" x 9"

**P/N: MI 0900900**



**Pivot Pin**  
Used in LCG20 crossbar

**P/N: CV 65435**



**Power Tilt Pin**  
9 1/2" length x 1 1/4" Diameter.

**P/N: CV 65715**



**Hydraulic Spade Pivot Pin**  
11 3/4" length x 1 1/4" diameter.

**P/N: CV 262637**



**Carriage Lift Cylinder Pin**  
6 1/4" length x 1" diameter.

**P/N: CV 65718**



**Power Tilt Body Pin**  
11 3/4" length x 1 1/2" diameter.

**P/N: CV 65716**



**Lift Cylinder Rod End**  
.980" diameter x 4 5/8" length.

**P/N: CV 65714**



**Weldment Arm Pin**

**P/N: MI 0806902**

## NEW STYLE



### Replacement Chevron Toolbox Door

Chevron toolbox only.

For Chevron boxes only.

**P/N: CV 37720A 33"**

**P/N: CV 37820A 49"**

**P/N: CV 37920A 65"**



### Replacement Chevron Hinge

Chevron hinge only.

#### FLAT STYLE

**P/N: CV 37730 33"**

**P/N: CV 37630 49"**

**P/N: CV 37930 65"**

#### L STYLE

**P/N: CV 37735 33"**

**P/N: CV 37835 49"**

**P/N: CV 37935 65"**



FRONT



BACK

### Chevron Toolbox Latch & Key

Replacement latch for Chevron box only.

**P/N: CV 54658**

**P/N: CV 54657 Gasket**

"Don't forget the hardware!"



FRONT



BACK

### Miller Toolbox Latch & Key

Replacement Miller Trimark Latch.

**P/N: MI 0303120**



FRONT



BACK

### Miller Toolbox Latch & Key

Stainless steel, single point latch, w/ lock. Keeps doors securely closed.

**P/N: MI 0302855**



Old Style

New Style

### Chevron Striker Plate

New style striker plate. Choose from old style pre 10' or new style 10' +.

**P/N: CV 376182**

**In The Ditch Toolbox Latch**  
Single point latch, w/ lock. Keeps doors securely closed.

**P/N: ITD 7316**



FRONT



BACK

### Phoenix USA Latch

Replacement stainless steel T handle latch for Phoenix USA model tool boxes

**P/N: PH 1283**



### Replacement Lock Cylinder

CH545 key and lock. Chevron only.

**P/N: CV AACH545LC**

### Tool Box Lanyard

Replacement lanyard for inside of toolbox.

**P/N: CV 5A221-Chevron**

**P/N: ITD 7116 - In the Ditch**

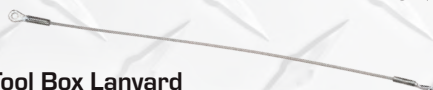

### Miller Striker Plate

Striker plate for Miller models.

**P/N: MI 945400800**

### Chevron Striker Pin

Use with CV 54658 latch.

**P/N: CV 54659**



### Chevron toolbox bracket

Left or right side galvanized frame-mount bracket.

**P/N: CV 37850L LCG**

**P/N: CV 37850R LCG**

**P/N: CV 0811136L**

**P/N: CV 0811136R**



### Miller Industries Tool Box Bracket

Left or right side mounting bracket

**P/N: MI 0805355L**

**P/N: MI 0805355R**



### IN THE DITCH QUICK MOUNTS

Fits Pro Series tool boxes

Quick mounts available in 4 different sizes to allow for perfect mounting height.

**P/N: ITD-1581 14.5"**

**P/N: ITD-1584 16.5"**

**P/N: ITD-1588 18.5"**

**P/N: ITD-1580 20.5"**

ITD1580  
20.5" Quick Mount  
Tuff Coat Black Finish

ITD1580 GLV  
20.5" Quick Mount  
Galvanized Finish

\*Also available in galvanized option for additional costs.

Eastern Division: 610-694-9234 | Western Division: 724-342-1800

For pricing and availability, visit us online at: [www.eastpennpartsonline.com](http://www.eastpennpartsonline.com)

# Tool Boxes & Storage

# TOWING EQUIPMENT



### Chevron Toolbox w/ Mounting Bracket

Chevron toolbox with brackets.

**P/N: CV 37700K 33"**

**P/N: CV 37800K 49"**

**P/N: CV 37900K 65"**

**stainless doors available: call for pricing**



### Chevron Toolbox Only

Chevron box only.

**P/N: CV 37700 33"**

**P/N: CV 37800 49"**

**P/N: CV 37900 65"**

### Aluminum Box Tray Top

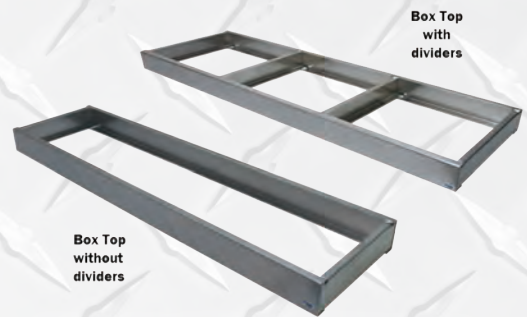

Box Top with dividers

Box Top without dividers

The Aluminum Box Top Tray is a great way to use the space on top of your tool box to store chain or other safety accessories. They are 4" tall and can be ordered with dividers or without dividers.

**P/N: ITD 1066 36" x 16"**

**P/N: ITD 1121 48" x 16"**

**P/N: ITD 1098 60" x 16"**

**P/N: ITD 1122 65" x 16"**

**P/N: ITD 1067 70" x 16"**



### In The Ditch Pro Series Toolbox

Tool boxes are customizable, can include shelving for additional cost.

**P/N: ITD1536 36"**

**P/N: ITD1548 48"**

**P/N: ITD1570 70"**



### Custom made box by East Penn

Designed to provide reliable, cost effective storage. Stainless steel cover and brackets available.

**P/N: SUBMB36 36"**

**P/N: SUBMB48 48"**

**Stainless Face: call for pricing**

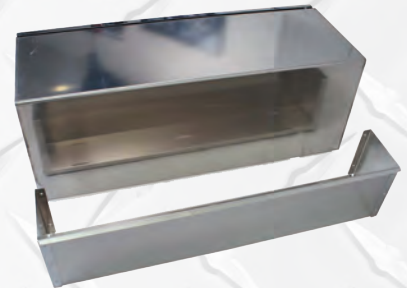

### Lumber Baskets

A solution for additional storage. Basket comes in aluminum and in different sizes to fit any tool box.

**P/N: ITD1282 48"**

**P/N: ITD1281 60"**

**P/N: ITD1280 70"**



### Bawer Tool Boxes

Black steel tool box with stainless steel lid:

**P/N: BAW TU813503 - 18x18x48**

**P/N: BAW TU814000 - 18x18x60**



### Bawer Tool Boxes

Aluminum tool boxes:

**P/N: BAW TU863500 - 18x18x48**

**P/N: BAW TU864000 - 18x18x60**

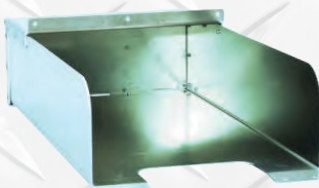

### Floor Jack Brackets

Slides right in place inside Pro Series Toolbox. Perfect fit for floor jack. Option also available for tunnel box or wrecker deck.

**P/N: ITD1284**

**P/N: ITD1293**

**Insert Tray**

### Pro Series Slide Out Drawer

*Perfect solution for your storage needs*

This drawer fits perfectly into your In The Ditch ProSeries toolboxes. Comes with a hardware kit and two drawer dividers.

**P/N: ITD1613**



Eastern Division: 610-694-9234 | Western Division: 724-342-1800  
For pricing and availability, visit us online at: [www.eastpennpartsonline.com](http://www.eastpennpartsonline.com)

# TOWING EQUIPMENT

## Winch Accessories



**Ramsey Winch Motor**  
Replacement winch motor for Ramsey 200 series.

**P/N: CV 71901** Series 8  
**P/N: WA 34788** Series 9



**Warn Free Spool**  
Replacement air free spool clutch kit and bearing

**P/N: WA 71370**



**Winch Motor**  
4 Ton, 5 Cubic Inch

**P/N: MI 0320147**



**Warn Replacement Winch**  
Exact replacement model for Chevron carriers and wreckers.

**P/N: CV 71109** 9000lb  
**P/N: CV 71106** 12000lb



**Ramsey 8,000lb Winch**  
Industrial hydraulic grade winch. Ideal for towing cars, vans and pickups. Motor not included.

**P/N: CV 71104**



**4 Ton Planetary Winch**

**P/N: CV 71102**



**Universal Tensioner (11" Wide)**  
Cable tensioner-roller guide. Wind wire rope evenly back onto your rear mount.

**P/N: 17-2**

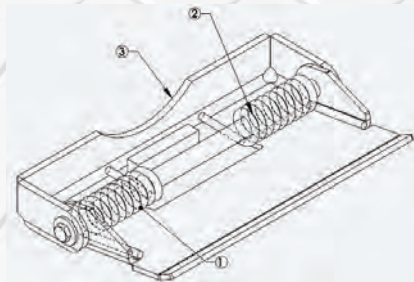

**Ramsey Spring Tensioner**  
This tensioner is specifically designed to be used on a 4 car application.

**P/N: CV A902210**

**Roller Horizontal CV A901520** Gen III  
**Roller Vertical CV 0809640** Gen III  
**Roller Vertical (short) CV 0940429** Gen II & III Ramsey  
**Tensioner Plate CV 0320137** Gen II Ramsey  
**Roller Horizontal CV A9R281** Gen II & III Warn  
**Tensioner Plate CV 0751268** Gen II & III Warn



**Tensioner Spring**  
**P/N: CV A90185**



**Universal Mounting Plate**  
Universal mounting plate. For use with 17-2. Will fit 11" wide drum.

**P/N: 17-2A**

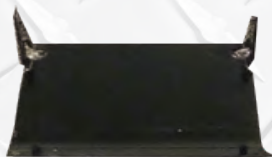

**Ramsey/Warn Tensioner Plate**  
Replacement tensioner plate for ramsey tensioner. For Chevron models.

**Ramsey**  
**P/N: CV A9021** 11" W  
**Warn**  
**P/N: CV A9009N** 7<sup>3</sup>/<sub>4</sub>" W



**Warn Tensioner Plate**  
Replacement tensioner plate for warn tensioner. For Chevron models.

**P/N: CV A9016** 10" W  
**P/N: CV A9017** 12" W



**Chevron Carrier Tensioner Assy**  
Complete Chevron carrier tensioner assembly. Plate, springs and tensioner.

**P/N: A9014K** Pre 2/07  
**P/N: A9014P** 3/07+

# Winch Accessories

# TOWING EQUIPMENT



Winch Tensioner Plate  
7" width

P/N: CV A9024DP



Under Wrap Winch  
Tensioner Plate  
11" Drum

P/N: CV 0751268



Ramsey Free Spool Shifter  
Replacement free spool shifter  
for Chevron models.

P/N: RW 251080



Roller Guide Assembly

P/N: CV 09018752



Cable Tensioner  
Sierra 10"

P/N: CV 03019524



Roller Guide Keep Pin  
6.7" length

P/N: CV 0809641

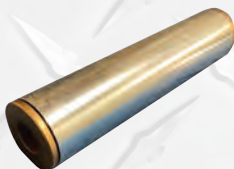

Roller Assembly  
1.75" Diameter x 8" Length

P/N: CV A9R281



Side Roller Assembly  
Applicable with Warn Tensioner.  
1 3/4" Diameter x 5 1/2" Length.

P/N: CV 315344

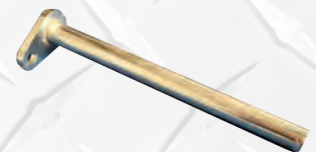

Roller Guide Keep Pin  
9" length

P/N: CV A902095

Ramsey Winch Block Adaptor

P/N: CV 31A05



Air Switch Guard

P/N: CV 18145



Air Shutter Valve

P/N: CV 71717



Air Regulator  
Chevron Carrier Winch

P/N: CV 71713



Heavy Duty Air Tensioner

P/N: MI 0304566



Flipper Valve Air Switch

P/N: CV 71716

# SIDE PULLERS

Call Either of Our Locations for the Latest Pricing on These Units.



### SP9000

This side puller is designed for customization. Valve body and hydraulic hoses are not included giving an option for custom hydraulic controls. 9000lb winch and tension plate.

**P/N: ITD 4518    \$ Call for Pricing**



### SP9000 with Integrated Controls

This side puller is ready to install. All that is needed is incoming hydraulic pressure, a hydraulic return line and connect power!

**P/N: ITD 4670    \$ Call for Pricing**

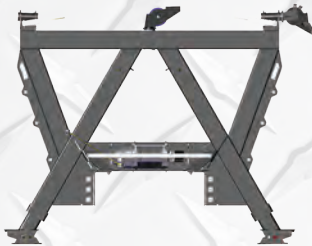

### SP12000

This side puller is designed for customization. Valve body and hydraulic hoses are not included giving an option for custom hydraulic controls. 12000lb winch and tension plate.

**P/N: ITD 4710    \$ Call for Pricing**



### SP12000 with Integrated Controls

This side puller is ready to install. All that is needed is incoming hydraulic pressure, a hydraulic return line and connect power!

**P/N: ITD 4711    \$ Call for Pricing**

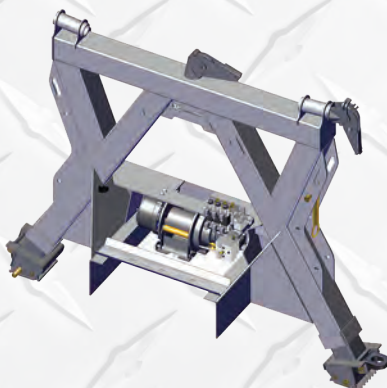

### SP20000 with Integrated Controls

This side puller comes ready to install. Just supply incoming hydraulic pressure, a hydraulic return line and connect power. 20,000lb winch with tension plate.

**P/N: ITD 4700    \$ Call for Pricing**



### Side Puller Boom Head

Accepts 3/8" and 7/16" wire rope and has a 12,000 lb rating.

**P/N: ITD 4229**

# SWITCHES



Back Up Alarm

P/N: DC 9115 square  
P/N: MI 0306385 round



Red Amber  
Toggle Switch - Red or Amber  
Universal 3 post lighted toggle switch.  
20 amp min load. Red  
P/N: DC 73312 red  
P/N: DC 73314 amber



20 Amp Toggle Switch - amber  
20 Amp universal toggle switch.  
P/N: AD 500804



50 Amp Circuit Breaker  
50 Amp universal two post circuit breaker.  
P/N: DC 71120



20 Amp Circuit Breaker  
20 amp universal two post circuit breaker.  
P/N: DC 72125



25 Amp Switch Circuit Breaker  
25 Amp M Series Rocker  
P/N: PU 2700500



50 Amp Auto Reset  
50 Amp high capacity auto reset.  
P/N: DC 76405



In Dash Switch w/ Circuit Breaker  
In Dash replacement switch w/ 20 amp circuit breaker built in.  
P/N: PH 031-0010



20 Amp Euro Switch  
On/off LED rocker switch  
P/N: DC 7700100



PTO Switch  
6 Post Muncie Chelsea w/ spring action. 3 Post Muncie w/ 3 prong on/off  
P/N: RM 30T35687 3P  
P/N: RM 30T37620 6P



Pressure Switch  
Electronically actuated pressure switch for Muncie PTO  
P/N: RM 30T60228



Pressure Switch  
P/N: RM 30T416420



Pressure Switch  
P/N: RM 30T37954



12V Engagement Magnet  
P/N: RM 35T36092



Muncie Activation Solenoid  
P/N: RM 35T40860

# FILTERS

## Light Duty



**Spin On Filter**  
Replacement spin on filter for wrecker / carriers.

**P/N: CV 76251**



**Hydraulic Filter Assemble with Housing**  
In board tank for carriers.

**P/N: CV 76270**



**Filter Assembly**  
Replacement filter housing assembly for wrecker and carrier applications.

**P/N: CV 76250**

**Replacement Drop In Filter**  
Stauff Filters



**Replacement Drop In Filter**  
Zinga Filters



## Heavy Duty



**Spin On Filter**  
Replacement spin on filter for Vulcan Heavy Duty

**P/N: MI 9018089**



**Spin On Filter**  
Replacement spin on filter for rotators and integrated heavy.

**P/N: MI 0300146**



**Spin On Filter**  
Replacement spin on filter for current integrated heavy.

**P/N: MI 0305040**



**Drop In Filter**  
Replacement Drop In filter for top beam rotators.

**P/N: MI 0307063**

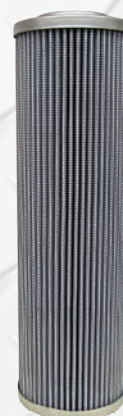

**Drop In Filter**  
Replacement Drop In filter for rotators.

**P/N: MI 0310636**



# High Visibility Outerwear

## OUTERWEAR

Never again will you have to worry about not being visible on the roadways. We carry a full line of high visibility Class 3 outerwear. All of our outerwear is ANSI compliant! From cold weather, to wind and rain, we have the gear to keep you protected from the elements while also keeping you visible to potential hazards. Buy in bulk to save money! All clothing is available in sizes L-3XL unless otherwise noted. Special orders can be made for alternate sizes, additional fees may apply.



Waterproof winter bomber jacket with removable liner.  
P/N: PET LBBJ-C3 L-XL  
P/N: PET LBBJ-C3 2XL-3XL



Two toned sweatshirt with liner  
P/N: PET LBHSW-C3 L-XL  
P/N: PET LBHSW-C3 2XL-3XL



High Visibility Short Sleeve T-shirt  
PN: PET LTS3 ANSI S-2XL



Waterproof rain pants  
P/N: PET LBPP-CE L-XL  
P/N: PET LBPP-CE 2XL-3XL

**SCREEN PRINTING  
CAN BE ADDED  
FOR ADDITIONAL  
FEES ON  
QUANTITIES OF  
10 OR MORE**



Waterproof rain jacket  
P/N: PET LBRJK-C3 L-XL  
P/N: PET LBRJK-C3 2XL-3XL



High visibility safety vest with zipper closure  
P/N: PET LVM3-CB1 L-XL  
P/N: PET LVM3-CB1 2XL-3XL



Waterproof leggings. Priced per pair  
P/N: PET LOG-CE  
One Size



Winter beanie cap  
P/N: PET LBE-S1  
One Size



[www.eastpennpartsonline.com](http://www.eastpennpartsonline.com)



**HAVE YOU HAD A CHANCE TO CHECK OUT OUR NEW EAST PENN EXCLUSIVE STRAPS ?**

# RETURN POLICY

You may return any new, unopened items sold and fulfilled by East Penn Truck Equipment within 10 days of delivery for a full credit to your account for the price of the item excluding shipping costs. Products must be in the original box, have a packing slip and reason noted for being returned. Once item is received, a credit will be issued to your account for the price of the item excluding shipping costs. We will only pay shipping costs if the return is a result of our error (incorrect or defective item). Items being returned within 10 days are subject to a 15 % restocking fee. Defective merchandise will be sent back to us via prepaid UPS freight for warranty consideration and repair by original manufacturer of the product. This policy excludes electrical parts which are non-returnable and non-refundable.

## SHIPPING INFORMATION

All products are shipped via UPS up to 100lbs. Items weighing over the allotted weight description will be shipped via truck freight. Shipping charges are applied to your invoice at the time of shipment. East Penn ships to all of the lower 48 states. East Penn Truck Equipment reserves the right to direct ship items from distributors if items are currently not in stock. Items not in stock will ship out as soon as the product becomes available to us. Shipping fees are subject to change at any time.

\*Disclosure: Copyright 11/1/2023 East Penn Truck Equipment. Please visit our online parts store to view the latest pricing

## FINANCING AVAILABLE!

East Penn offers financing on all trucks and equipment with a short credit application process and easy review process. Getting the truck of your dreams has never been easier!

Call our finance department today!



Eastern Division: 610-694-9234 | Western Division: 724-342-1800  
For pricing and availability, visit us online at: [www.eastpennpartsonline.com](http://www.eastpennpartsonline.com)



# EAST PENN

## TRUCK EQUIPMENT INC

THE PRODUCTS THE PEOPLE. THE PRIDE...SINCE 1998

### WHY EAST PENN TRUCK EQUIPMENT?

- Knowledgeable staff
- Finance programs - Available with quick turnaround, simple credit application and new start up programs
- Expert installation, custom manufacturing, state of the art paint booth - This process ensures our total commitment to provide you with quality and custom satisfaction for many years of trouble free service
- Factory trained installation team
- All makes and models available



SALES • SERVICE • PARTS • RESTORATION • PAINT

[WWW.EASTPENNTRUCKS.COM](http://WWW.EASTPENNTRUCKS.COM)



ISUZU

